

LIBRARY
OF THE
UNIVERSITY
OF ILLINOIS

572.05

FA

v. 35-37

UNIVERSITY LIBRARY

UNIVERSITY OF ILLINOIS AT URBANA-CHAMPAIGN

The person charging this material is responsible for its renewal or return to the library on or before the due date. The minimum fee for a lost item is **\$125.00, \$300.00** for bound journals.

Theft, mutilation, and underlining of books are reasons for disciplinary action and may result in dismissal from the University. *Please note: self-stick notes may result in torn pages and lift some inks.*

Renew via the Telephone Center at 217-333-8400, 846-262-1510 (toll-free) or circlib@uiuc.edu.

Renew online by choosing the **My Account** option at: <http://www.library.uiuc.edu/catalog/>

FEB 04 A.M.



72.05
A
37'

CRANIOMETRY
OF
AMBRYM ISLAND

WILFRID D. HAMBLY

FIELDIANA: ANTHROPOLOGY
VOLUME 37, NUMBER 1
Published by
CHICAGO NATURAL HISTORY MUSEUM
FEBRUARY 28, 1946

CRANIOMETRY
OF
AMBRYM ISLAND

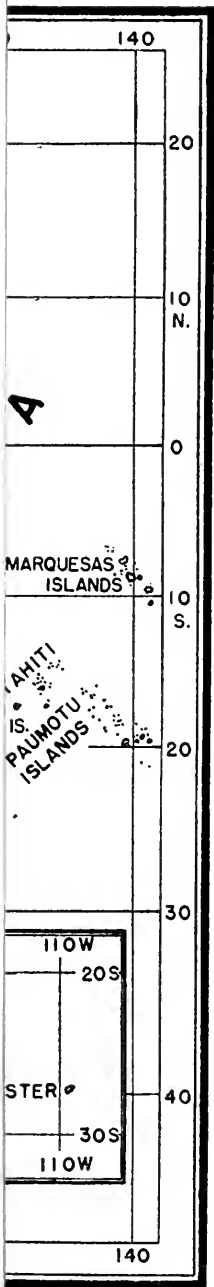

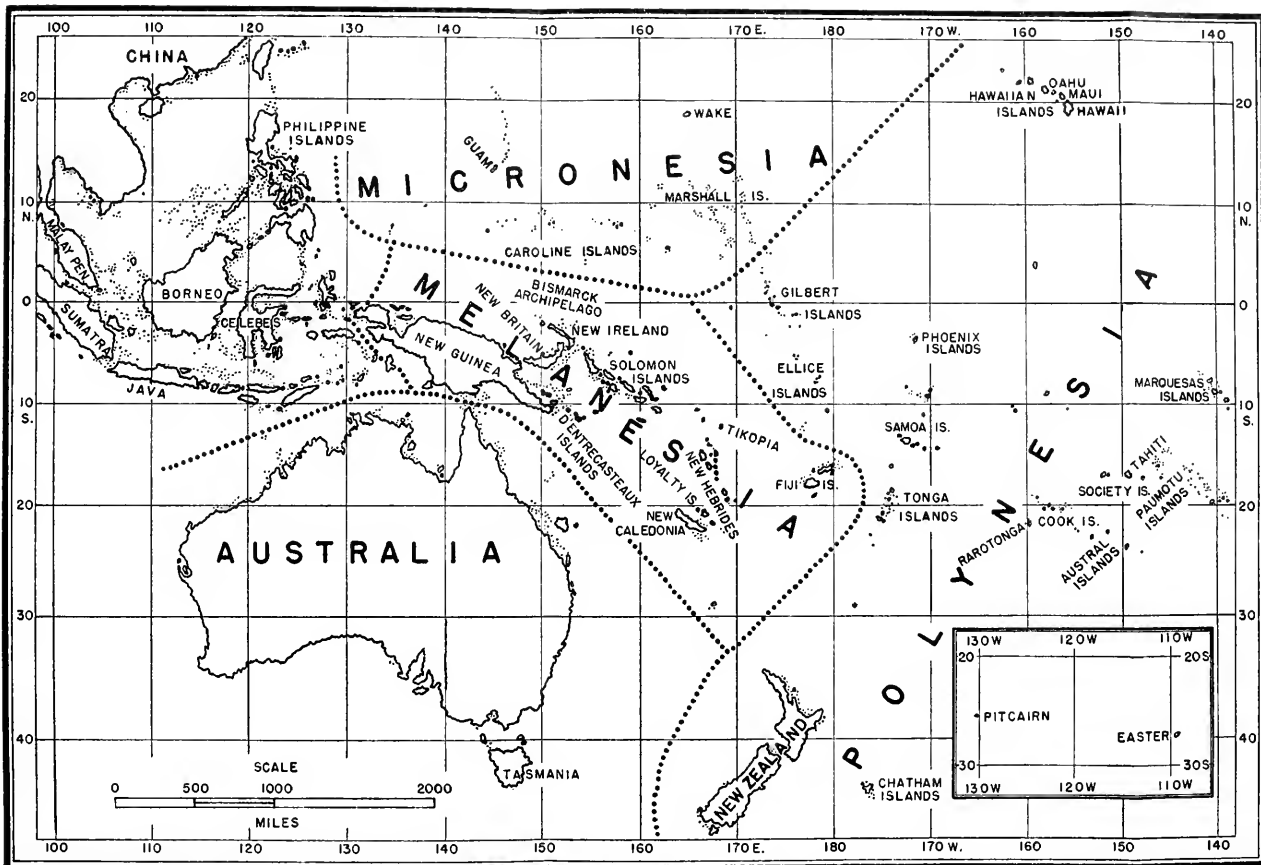

Courtesy of the *Geographical Review*, published by the American Geographical Society of New York

PRINCIPAL ISLANDS OF THE SOUTHWEST PACIFIC

CRANIOMETRY
OF
AMBRYM ISLAND

WILFRID D. HAMBLY

Curator, African Ethnology

FIELDIANA: ANTHROPOLOGY

VOLUME 37, NUMBER 1

Published by

CHICAGO NATURAL HISTORY MUSEUM

FEBRUARY 28, 1946

THE LIBRARY OF THE

MAR 9 1946

UNIVERSITY OF ILLINOIS

PUBLICATION 576

PRINTED IN THE UNITED STATES OF AMERICA
BY THE CHICAGO NATURAL HISTORY MUSEUM PRESS

CONTENTS

	PAGE
I. INTRODUCTION	1
Geography	2
Photographs of Ambrym Natives	3
Sex Differences and General Appearance of Ambrym Skulls	4
Age Grouping of Melanesian Skulls	9
II. TECHNIQUE	16
Definitions and Arrangement of Tables	16
Instruments Used	19
Cranial Capacities	21
Statistical Methods	24
III. SEX DIFFERENCES IN AMBRYM SKULLS	26
Proportion of Males to Females	26
Literature on Sex Differences of Crania	27
Contour Drawings	29
Sex Ratios: Ambrym, New Guinea, New Britain	30
Magnitude of Sex Differences	32
Variability of Traits in the Sexes	36
Variability of Traits in Relation to Race	38
IV. MELANESIAN CRANIAL TYPES: AMBRYM, NEW GUINEA, NEW BRITAIN	42
Contour Drawings	42
Statistical Comparison of Average Measurements	42
V. AUSTRALIAN, NEGRO, AND POLYNESIAN TRAITS IN AMBRYM (MELANESIAN) SKULLS	49
Method of Comparing Average Measurements	49
The Nature of Likeness and Unlikeness	49
Ambrym Skulls: Their Racial Resemblances and Differences outside Melanesia	50
Pictorial Evidence	50
Available Data and Their Defects	51
Preliminary Inspection of Average Measurements	53
Summary of Statistical Comparisons	58

	PAGE
VI. SUMMARY AND CONCLUSIONS (by chapters)	62
APPENDIX 1: Tables of Individual Measurements of Embryonic Skulls	69
APPENDIX 2: Racial Characters of Lower Jaws and Teeth	79
APPENDIX 3: Inter-racial Standard Deviations	87
BIBLIOGRAPHY	125
INDEX	147

LIST OF ILLUSTRATIONS

PLATES

1-30. Skulls of Ambrym Island, of various types, and of both sexes, that have been measured. Identification numbers are given in the legends. Reference should be made to the tables (pp. 71-78) for details of measurement.

TEXT FIGURES

	PAGE
1. Village scene, west Ambrym	3
2. Old man of west Ambrym	5
3. Woman of north Ambrym	5
4. Man of north Ambrym	6
5. Two old men of west Ambrym	6
6. Men of west Ambrym	7
7. Palatometer	21

MAPS

Principal islands of the southwest Pacific	Frontispiece
New Hebrides Islands	viii

DRAWINGS

	FACING PAGE
<i>Sex Contours of the Skull: Ambrym (natural size)</i>	
Vertical	38
Horizontal	38
Sagittal	38
<i>Melanesian Contours: Ambrym, New Guinea, New Britain (natural size)</i>	
Vertical	46
Horizontal	46
Sagittal	46
<i>Racial Contours: Ambrym, Australian, Negro, Maori (natural size)</i>	
Vertical	54
Horizontal	54
Sagittal	54

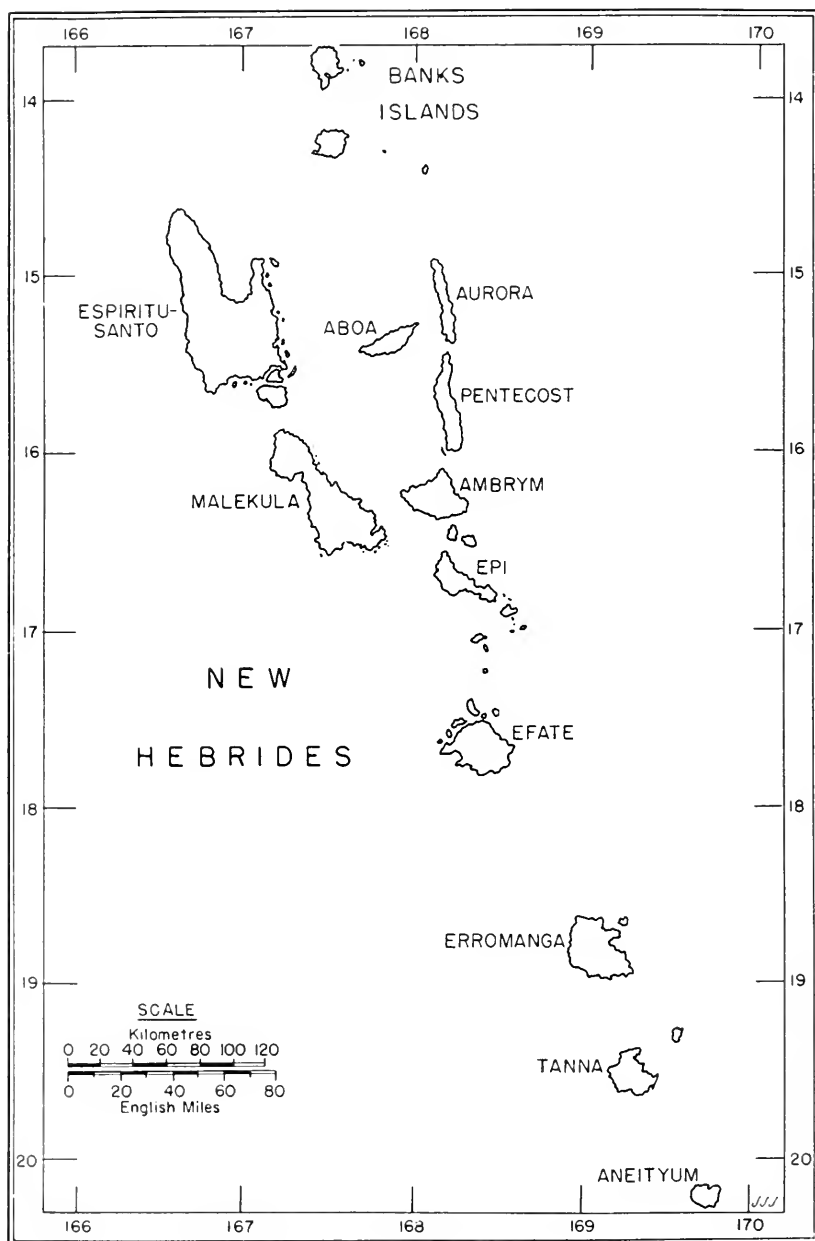

I. INTRODUCTION

The following table gives the details of a large collection of Melanesian skulls, most of which were brought to Chicago Natural History Museum by the late Dr. A. B. Lewis, leader of the Joseph N. Field South Pacific Expedition, 1909-13.

The plan of research on this material arranges for the publication of periodical reports, each of which deals with the craniometry of a definite geographical region. Finally, the main results of the several contributions will receive comparative study in conjunction with a survey of the most important data that have been published by institutions other than Chicago Natural History Museum.

PARTICULARS OF 429 ADULT MELANESIAN SKULLS IN MUSEUM COLLECTION

PROVENANCE	COLLECTOR	NUMBER OF SKULLS		REMARKS
		Male	Female	
Admiralty Islands	A. B. Lewis	3	2	From north coast of the main island, Punam
Ambrym	A. B. Lewis	20	11	New Hebrides group
Malekula	A. B. Lewis	36	19	New Hebrides group
New Caledonia	A. B. Lewis	14	2	Numbers 43102-109 from Oubatch, remainder from adjacent village of Oubia
New Ireland	A. B. Lewis G. A. Dorsey	11	2	From Anir, a small island bordering on Micronesia
Solomon Islands	G. A. Dorsey W. D. Webster J. F. G. Umlauff A. B. Lewis	6	0	South Bougainville Kia Ysabel Santa Ana Vella Lavella
St. Matthias	A. B. Lewis	3	0	Northwest of New Ireland, bordering on Micronesia
New Guinea	A. B. Lewis	124	70	For details of provenance see Hambly (1940, pp. 88-89)
New Britain	R. Parkinson	63	43	Gazelle Peninsula; see von Bonin (1936)
Totals		280	149	429 male and female skulls

The reports published up to date relate to the largest collections, namely, those from New Britain (von Bonin, 1936) and New Guinea (Hambly, 1940). The present report deals with thirty-one skulls from the island of Ambrym; I have not yet discovered any published or unpublished craniometrical data from this island.

For discussion on matters relating to Melanesia, and for assistance in selecting photographs made during his expedition, I am greatly indebted to my late colleague Dr. A. B. Lewis, for many years Curator of Melanesian Ethnology in this museum.

GEOGRAPHY

The small island of Ambrym, measuring about twenty-three by fifteen miles, is situated in the east-central portion of the New Hebrides group, in the western Pacific (see map, p. viii). The island is almost exactly midway between the extreme southeast of New Guinea and the northerly extremity of New Zealand. The exact location is Lat. $16^{\circ} 10' S.$, Long. $168^{\circ} 05' E.$ Brigham's map (1900, p. 81) shows the geographical relationship of Ambrym to near-by Malekula, which is about twenty miles away. This proximity of the two islands is a fact that will be of service in a future publication, in which the undeformed skulls of Ambrym may be used as a control and a basis of comparison for the study of a group of deformed skulls from Malekula.

Museum records do not state from which part of Ambrym the skulls were collected but, in view of the small size of the island, the exact provenance is not so essential as in case of larger territory. Brigham (1900, p. 36) states that Ambrym is volcanic and has a general elevation of about 3,000 feet.

The map (Frontispiece) gives the principal locations with which we are concerned. The Statesman's Year Book (Epstein, 1941) is a compendium of geographical, economic, and political information, in which the islands of the New Hebrides group are described in detail. The spelling of geographical names allows some latitude. The spelling recommended by the Permanent Committee for Geographical Names (see Bibliography) is the one usually adopted in this publication.

Ethnological data for the New Hebrides are to be found in Speiser (1923b), who gives a very large bibliography, and in Deacon (1934). Contributions to languages of this island group appear in the publications of Ray (1893) and Codrington (1885), and in the Bulletins

of the London School of Oriental Studies (see Ivens, 1933-35a-d). I feel that the ethnological and linguistic data are the work of specialists, and that my own contribution to problems of Melanesia should be confined to craniometrical studies; yet there may be a possibility of future collaboration of specialists in order to solve problems



FIG. 1. Village scene, west Ambrym.

of migration, miscegenation, and present distribution of physical types.

PHOTOGRAPHS OF AMBRYM NATIVES

Photographs (figs. 1-6) showing physical types from Ambrym indicate, according to my judgment, the presence of both Negroid and Australoid traits, but I can see nothing of the Polynesian physiognomy.

The pictures support the observations of Speiser (1923a), who states in his general description that Melanesians usually have a very dark skin and curly hair that is crisp in texture. The head is dolichocephalic, the forehead is sloping, and the brow ridges are

well developed. The nose is short, broad, and considerably depressed in the region of nasion. The broad mouth has heavy lips. There are noticeable variations in physical type from island to island, and also within the larger islands. One does not doubt this statement, but the impressions should be supported by craniometrical and other quantitative observations. Speiser's statement is certainly true for the island of New Guinea, where, in head form at least, there are distinct littoral types in villages of the northern and southern coasts. The differences are, however, not so great as to forbid a pooling of measurements (Hambly, 1940).

Except for the prominence of the nose, the woman of north Ambrym (fig. 3) has a distinctly Negroid profile. The man on the left (fig. 6) is, I think, of Negroid and Australoid physiognomy, though Negroes are not usually so hirsute. The man of north Ambrym (fig. 4) recalls Australian types from Cape York Peninsula, which is near the Melanesian region of New Guinea. The profile of a male (fig. 2) and the full view of a male (fig. 5, left) show likeness to many photographs of central Australian aborigines given in Spencer and Gillen's *Across Australia*.

These general impressions should be tested by comparing average measurements of many skull traits of Australian aborigines, African Negroes, and men of Ambrym, in the way I propose to test Speiser's statement that Melanesian cranial patterns differ from one island to another.

SEX DIFFERENCES AND GENERAL APPEARANCE OF AMBRYM SKULLS

A separate chapter is devoted to study of sex differences, so for the present I may confine my remarks to general observations. The sexing of the skulls presented little difficulty, since the sex characters in these, as in all Melanesian skulls, are well defined.

When one views the male skulls before recording the measurements, the first impression is one of size, weight, ruggedness, and a high vault. The brow ridges are massive; so also is the occipital torus in many skulls, and the mastoids are generally large.

The facial view further supports the general impressions conveyed by inspection of the cranium, and by examination of the photographs (plates 1-30). Eye sockets are rectangular in shape and thick around the margins. The interorbital space is wide, and the region of the nasal suture is much depressed. The palate is deep, short, and broad, with a horseshoe shape. Alveolar prognathism is pronounced in both males and females, and deep submalar



FIG. 2. An old man of west Ambrym, an Australoid type.

FIG. 3. A woman of north Ambrym, a somewhat Negroid type.





FIG. 4. A man of north Ambrym, more Australoid than Negroid in appearance.

FIG. 5. Two old men of west Ambrym. Both are of the Australoid type.



depressions are noticeable. Krogman (1932) in a morphological study of Australian skulls in the Royal College of Surgeons, London, stresses several of these features that characterize Ambrym males.

Malar bones are thick, and this feature, combined with a considerable bizygomatic width, adds to the general heaviness of the



FIG. 6. Two men of west Ambrym. The man on the left is of Negroid and Australoid physiognomy. His hair resembles that of the African Negro but is more bushy. Australian aborigines have wavy hair.

face. The somewhat short distance from nasion to alveolar point (G'H, upper facial height) gives a scowling appearance, which, from the same cause, is characteristic of the expression of Tasmanians and of Bushmen of South Africa.

In female skulls the ruggedness is greatly modified, and we have to note the smaller brow ridges, and the less robust mastoids. In female skulls the occipital torus is either absent or much less rugged than in male skulls. The female skull looks smaller and feels lighter than the male skull. The eye sockets of female skulls appear rounder and have thinner margins than those of males. These and other sex

differences I shall test by comparing average measurements of various traits in males and females.

My interest is mainly biometrical; not that the importance of anatomical details is unrecognized, but I feel that for the purpose of exact comparative study quantitative data are more fundamental.

On the contrary Ashley-Montagu (1941) is dubious of the value of research done by "caliper anthropologists" who lack training in practical anatomy, and he speaks of morphology as "the alphabet of physical anthropology." Statistics, so he feels, threatens to assume the place once occupied by morphology. This critic also points out that genetics is an essential part of well-rounded studies. There are, of course, relatively few physical anthropologists who can claim a full and flawless training.

Wood-Jones (1931b, p. 181) "feels that the future study of racial affinities is not destined to develop in the direction of systems of measurement, or of refined mathematical treatment of measurements."

For my own part I have never doubted the value of anatomical and morphological contributions to a comparative study of intra-racial and inter-racial types; but after reading pages of the morphologist's minute descriptions of asymmetry, sutures, epipteric bones, supraorbital foramina, sphenomaxillary fissure, jugular fossa, styloid process, and what not, and after noting his opinion that the A's appear to have a cranial vault that is higher than that of the B's, and that the C's look somewhat more Negroid than the D's, there is still the desire to reduce some of this astute observation to something like a quantitative statement.

While fully recognizing the difficulties of measuring by standardized techniques, and of the pitfalls in statistical methods, especially when attempting exact comparisons, I suppose that no critic would deny that correct measurement is fundamental to all the exact sciences, and the aim of the biometric school is to make craniometry such a science.

A statistician may of course make an error of judgment in handling his data; but, despite such an occasional occurrence, he may yet survive the wrath of his critics and live to serve the cause of craniometry very well. An anatomist who cuts himself, not with a misused statistical method, but with a scalpel, still hopes to remain a competent anatomist, provided he does not die from infection. He must be magnanimous enough to extend the same privilege to biometricians who, in a pioneer field, are confronted with some very

difficult problems that often leave a considerable margin of individual judgment for their treatment.

The "caliper anthropologist" assumes that he is viewing the problem from one particular angle, without pretense that his contribution is the whole story. On the contrary he hopes for and fully welcomes the contributions of the anatomist, the morphologist, and the geneticist as a necessary and complementary approach to biometrical methods.

Anomalies in the Ambrym series seem to be few. Dentitions have, unfortunately, suffered much post-mortem loss; but one may say that teeth, though well worn, are not carious. Skull 43072 (plate 14) has an unusually deep palate, and 43060 (plate 18) has an exceptionally heavy brow ridge. Part of the frontal suture persists in skull 43089. The mastoids are disproportionately large in 43067 and in 43066.

In female skull 43078 (plates 26-30) the mastoids are small even for a female. The nose is very narrow, and alveolar prognathism in the extreme is shown in both the mandible and the maxilla. Submalar depressions in this skull are exceptionally deep.

Skull 43069 (plate 21) well illustrates the roundness and slender margins that are usually found in the eye sockets of female skulls. This specimen also shows the characteristically female forehead, which lacks the supraciliary ridges of the typical male.

Such are the general impressions of normality and aberrancy that arise from a preview of the Ambrym skulls before they have been drawn or measured. In all probability the large scale photographs of skulls in front, side, and back views will satisfy the anatomical curiosity of those who wish for further details. The photographs (plates 1-30) indicate the strength of muscular attachments, types of sutures, details of the palatal structure, and other minor points that do not particularly concern us in a biometric study of the principal dimensions and angles of the skull.

AGE GROUPING OF MELANESIAN SKULLS

A student who wishes to make a thorough survey of age groupings should begin with the historical and bibliographical summary given by Ashley-Montagu (1938). This writer states that the degree of obliteration of cranial sutures has served as a criterion for evaluating the ages of skulls since the sixteenth century, but he begins his summary from fairly modern times, about a century ago.

One who wishes to get the gist of the subject as quickly as possible will turn to Frédéric (1905-6), where he will find eighty-two pages of illustrated discussion, including an extensive bibliography.

The contribution of Bolk (1915) on premature obliteration of sutures of the human skull is important, but not in connection with the age grouping of our adult Melanesian skulls, since Bolk is dealing with juvenile material. Bolk's data do, however, impress the need for caution in estimating ages from closure of sutures, for he found a premature obliteration, in either one or more sutures, in 343 skulls, a number which was 19 per cent of his population. Bolk states (p. 522) that the frontal suture, which normally should close between the second and third year, persists to the adult age in 6 per cent of the skulls he examined; there was, however, a variation of persistence with race.

An excellent account of the determination of age by closure of sutures is that of Todd and Lyon (1924) who diagnose ages in five-year groupings. All writers are agreed that closure of cranial sutures must not be accepted as sole evidence of age; judgment should be aided by noting eruption of teeth and the degree of wear to which they have been subject. The degree of absorption of the alveolar border is also a condition that should be taken into account. The dictum of Todd and Lyon (p. 371), that ectocranial closure progresses more slowly and shows more individual variation than endocranial, is generally accepted. My own method was examination of the internal sutures of the skull by introducing a small electric light bulb through the foramen magnum.

A part of the technique of Todd and Lyon which is not so generally accepted is the classification of skulls in five-year age groups. Frédéric (1905-6) thought that estimation in ten-year periods was more reliable, and Hrdlička (1939, p. 46) agrees that the estimation should be in ten-year periods because of the difficulty of correctly judging the age of any individual skull. Hrdlička believes that cutting of the skull is necessary to see how far synostosis has advanced in the sutures. True as this may be, one cannot think of a method more likely to make an itinerant student an unwelcome guest in a laboratory of physical anthropology.

My own publication (1940, p. 122) suggests that the possibility of an age diagnosis in five-year periods is supported by the consistency of conclusions when different samples are so treated. If the method of classifying in five-year periods were as hazardous as some critics would have us believe, one would expect more dis-

AGE GROUPING OF CRANIA

LOCALITY	Males										Females					TOTALS MALES AND FEMALES
	20-25	25-30	30-35	35-40	40-45	45-50	Totals	20-25	25-30	30-35	35-40	40-45	45-50	Totals		
Duke of York Island...	2	21	13	26	8	13	83	3	12	7	3	1	..	26		
New Britain.....	2	1	4	4	2	2	15	1	3	5	0	1	..	10		
New Hebrides.....	..	4	2	2	..	1	9	1	2	..	4	7		
Fiji Islands.....	6	19	7	13	2	4	51	4	8	2	0	0	1	15		
Totals.....	10	45	26	45	12	20	158	9	25	14	7	2	1	58		

Data above from Krause (1881)

New Guinea.....	22	24	9	10	20	10	95	39	16	4	3	2	..	64
Malekula.....	3	3	3	4	7	15	35	6	4	1	2	6	3	22
St. Matthias.....	2	1	3	0
New Caledonia.....	1	..	1	2	2	7	13	1	..	1	1	3
Admiralty Islands.....	1	1	..	1	3	1	..	1	5
Solomon Islands.....	2	1	1	2	6	6
Ambrym.....	..	3	1	2	9	5	20	4	1	1	1	..	4	11
New Ireland.....	5	2	3	3	13	0
Maori.....	1	3	1	..	2	..	7	0
Hawaiian Islands.....	3	4	2	4	4	..	17	0
Totals.....	40	41	18	24	47	42	212	51	21	8	6	8	8	102
Totals.....	10	45	26	45	12	20	158	9	25	14	7	2	1	58

Hambly's data from Chicago Natural History Museum collections. All are unpublished except the first item, from *Cranometry of New Guinea, 1940*.

All totals in bold-faced type. Total: 370 males + 160 females = 530.

harmony in the age grouping of different skull populations. No matter whether we are testing the northern New Guinea group or the southern, or whether we segregate or combine the sexes, we find that the number of skulls is very great in the 20-25 and 25-30 year age periods, but that there is an appreciable decline of numbers in the 30-40 year period. If we consider our total New Guinea population we find that 52 per cent of the skulls are in the 20-30 year group. In the next decade, 30-40 years, 13.4 per cent of the skulls are classified. About 16.4 per cent occur in the 40-50 year group, and about 18 per cent are more than 50 years of age.

In classifying additional collections of Melanesian skulls I have adopted the method of arranging in five-year periods; this technique was followed by Krause (1881), who classified a total of 216 Melanesian skulls. Two tables of age groupings are given (pp. 11, 12) but in the first table the data of Krause have been kept separate from my own because Krause based his judgment on external conditions of the sutures. In the second table the data are combined in ten-year age groups in deference to the somewhat general opinion that this is the preferable method. The total population considered in the table combining my data and those of Krause gives a total of 530 skulls (370 males, 160 females).

AGE GROUPING OF CRANIA

AGE GROUPS	HAMBLY'S DATA			KRAUSE'S DATA			HAMBLY'S AND KRAUSE'S DATA COMBINED		
	Males	Females	Totals	Males	Females	Totals	Males	Females	Totals
20-30	81 38.2	72 70.6	153 48.7	55 34.8	34 58.6	89 41.2	136 36.7	106 66.2	242 45.7*
30-40	42 19.8	14 13.7	56 17.8	71 44.9	21 36.2	92 42.6	113 30.5	35 21.9	148 27.9
40-50+	89 42.0	16 15.7	105 33.4	32 20.2	3 5.2	35 16.2	121 32.7	19 11.9	140 26.4
Totals	212	102	314	158	58	216	370	160	530

The percentages, which are in bold-faced type, have their errors of sampling, but these are not of a magnitude to affect our study of general trends. The probable error of a percentage is given by a formula which, in case of the percentage marked with an asterisk in the table above, would be

$$\sqrt{\frac{45.7 \times 54.3}{530}} = \pm 2.2.$$

According to my data about 38.2 per cent of males die in the 20-30 year period, and with this estimate the 34.8 per cent arrived at by Krause is in good agreement. For this early age period

the mortality of females is even greater than that of males. My analysis shows that 70.6 per cent of female skulls should be classified in the 20-30 year group, while Krause estimates that 58.6 per cent should be so placed. A pooling of male and female skulls shows that 48.7 per cent (Hambly) or 41.2 per cent (Krause) of the total population are in the 20-30 year group. In other words our sample suggests that nearly half the people fail to survive the age of 30 years.

An investigation of longevity, as judged by the ages of skulls from New Britain now in the collections of the Chicago Natural History Museum, was undertaken by Dr. K. Wessely of the University of Illinois Medical School, in connection with his research on conditions of lower jaws. The age grouping was carried out in five-year periods, but these have been rearranged in the ten-year groupings adopted in my second table (p. 12). The result of Wessely's grouping is as follows:

AGE GROUPING OF 104 MALE AND FEMALE SKULLS FROM NEW BRITAIN

Age	Number of male skulls	Number of female skulls
20-30	30	26
30-40	20	12
40-50	14	2
Totals.....	64	40

Once again, in this independent census, we see the high mortality of both males and females in early age periods. About 88 per cent have failed to surpass the age of 40 years.

An investigation of longevity among living races who keep no records is always open to criticism for many obvious reasons, but attempts have been made. I made a summary of investigations among living Negro tribes of Africa (1937) and also recorded (1938) my observations among the Ovimbundu (Portuguese West Africa). Investigation was made among two successive generations of the Ovimbundu, and the conclusion was reached that a high birth rate is offset by a heavy mortality up to 35 years of age. The death rate of brothers and sisters of the informants was estimated at 40.3 per cent of births in this period, and for children of the informants the death rate seemed to be about 38.6. Sharp (1940, pp. 488-492) made a similar but more extensive inquiry into demographic data among Australian aborigines.

Comparison of estimates of mortality by ages of preserved skulls and by inquiry among the living cannot be regarded as satisfactory

in technique since both methods are open to error. Nevertheless, the estimates of mortality so arrived at are in fair agreement. I considered a skull population of Melanesians and came to the conclusion that about 45.7 per cent of the population succumbed in the 20-30 year period. The estimate for the living Ovimbundu gave a probable mortality of 38.6 to 40.3 per cent before the age of 35 years.

The ethnological facts, though by no means adequately studied, can provide a reasonable explanation of the incidence of mortality.

For women the child-bearing age would be from 15 to 30 years, and in this period the most strenuous work would be performed. From 20 to 30 years of age all males would probably be engaged in warfare and head-hunting, both dangerous pursuits in which the mortality is likely to be high; but at the age of 30 the strenuous period of exposure to danger has passed. A woman of 30 years would be regarded as an older spouse in a polygynous family in which hard work would be relegated to the younger wives; and although no definite information is available, it is probable from what is known of primitive people that the active sexual and child-bearing life declines quickly after the age of 30 has been attained. Possibly males who have passed 30 years of age graduate into the governing class of village elders who are no longer exposed to the hazards of warfare and head-hunting.

Moreover, in the early age period of 20-25 years a selective process would be at work eliminating those who were unable to stand the strain of life. The strong survivors who had proved their resistance to disease, and had in addition been fortunate enough to escape the hazards of childbirth in case of women, and of warfare in case of men, could anticipate that after attaining the critical age of 30 years their chance of survival to the age of 45-50 years would be fairly good when judged by the standards of longevity prevailing in their particular environment.

To the foregoing suggestions we may add the explanation that high mortality at all ages results from lack of understanding of the nature of disease. Possibly some rational treatment exists, but complete reliance on diagnosis by magical means and therapy by similar processes is more probable.

Strandskov (1942) has discussed sex ratios at birth, but so far as I am aware there exists no complete cranial study of longevity among prehistoric, early historical, and present-day backward races. Some contributions may be noted. Todd and Lyon (1927) examined skeletal records of mortality and pointed out the high death rate in

the 20-30 year age period for Roman colonists in Africa and Spain. In mediaeval England in the eleventh century there was, according to skeletal testimony, a high mortality in the period from 35-40 years of age.

Krogman (1940, pp. 8-10) studies the endocranial sutures of skulls from Tepe Hissar in northeastern Iran and states that the evidence points to a mortality peak in the mid-third and early fourth decade of life (25-35 years). There are, according to this evidence, very few who reach the fifth decade. According to the figures of Krause and myself only 140 male and female Melanesian skulls out of 530 (26.4 per cent) attain the fiftieth year. A few of the skulls might be a little more than 50 years of age, but these are few, and the diagnosis is too uncertain to justify the adoption of a 50-60 year age group in the table.

Hooton (1930, p. 23) gives age groups of skulls excavated at Pecos in north-central New Mexico, but the age groups he adopts do not admit of ready comparison with those we have discussed. Yet Hooton (p. 25) emphasizes the very high mortality between 35 and 54 years.

Todd and Lyon (1927, p. 495) concluded that longevity is a rather modern achievement resulting from greater safety and improved conditions of living, and that the difference between the age of greatest mortality in primitive and ancient people on one hand, and of modern civilized humanity on the other, is roughly 30 years.

I discussed the high mortality existing among extant primitive (preliterate) peoples (1940, p. 124) and appended a list of references for students of the social and psychological problems involved in contact of Europeans and aborigines. Such contacts often involve decline and even extinction of the latter, sometimes without the adequate physical causes such as new conditions of labor, or changes in clothing and diet.

II. TECHNIQUE

DEFINITIONS AND ARRANGEMENT OF TABLES

The following table is a list of definitions and symbols for measurements which have been used during research on the skulls of Ambrym.

Circumferences GLU and U are still found to be useful measurements of the circumference of the skull, and the difference between them gives an idea of the size of the supraciliary ridges. This method of measurement gives data for the comparison of the frontal development in the sexes, or in series of skulls from two different regions. Hrdlička (1939, p. 128) classes U with obsolete measurements, and among these he places S, the sagittal arc, also BQ', the transverse arc. He thinks that U is replaceable by the cranial module, which is the mean of the length, breadth, and height of the skull. The tables of measurement for skulls of Ambrym do not include this measurement, but modules can easily be calculated since the individual and also the average measurements for L, B, and H' are tabulated.

To aid comparative studies it is advisable to measure the height of the nose in three ways, right, left, and nasion to nasal spine, though the spinal measurement NH' seems to be the least desirable of the three, owing to varying position and probable abrasion of the spine. Usually, however, NHR, NHL, and NH' have about the same average measurement for the same series of skulls. For example, the average measurements for these traits for 124 male skulls of New Guinea are 50.1 ± 0.17 , 50.4 ± 0.17 and 49.1 ± 0.31 , respectively. It may be that in certain comparative studies we may have to use an average NH' to compare with an average NHL, or with average NHR. Craniometrists do not usually pamper their readers with all three measurements.

One might perhaps discard measurements O_1' and lachrymal O_1 , for which the presence of the delicate lachrymal bone is necessary. On the contrary, distance O_1 is measured between two bony margins that are seldom broken. In a collection of 124 male skulls from New Guinea O_1 was measurable in 128 instances, whereas O_1' and lachrymal O_1 could be measured on less than half that number.

LIST OF MEASUREMENTS AND INDICES TAKEN ON THE SKULLS OF AMBRYM

- L=Length, maximum glabello-occipital, in the median sagittal plane
 B=Breadth, maximum calvarial
 B'=Minimum frontal breadth between the temporal lines
 H'=Height, basion-bregma
 LB=Length of base, basion-nasion
 S₁=Frontal arc, nasion-bregma
 S'₁=Frontal chord, nasion-bregma
 S₂=Parietal arc, bregma-lambda
 S'₂=Parietal chord, bregma-lambda
 S₃=Occipital arc, lambda-opisthion
 S'₃=Occipital chord, lambda-opisthion
 S=Sagittal arc, nasion-opisthion
 GLU=Horizontal arc through glabella and the most prominent part of the occipital region
 U=Horizontal arc through ophryon and the most prominent part of the occipital region
 BQ'=Vertical arc over bregma from porion to porion
 GB=Breadth of face between the lowest points of the maxillozygomatic sutures
 J=Maximum bizygomatic breadth
 G'H=Height of upper face, nasion to alveolar point
 GL=Basion to alveolar point
 NHR and NHL=Nasal height, right and left. Nasion to the lowest edge of the pyriform aperture on the right or left side
 NH'=Nasal height, nasion to the base of the anterior nasal spine
 NB=Greatest breadth of the pyriform aperture
 O₁R=Breadth of right orbit, from maxillo-frontale (the point of intersection of the anterior lachrymal crest or its prolongation) to the fronto-maxillary suture
 O₂R=Height of the right orbit
 O₁L=Breadth of the left orbit
 O₂L=Height of the left orbit
 O₁'(R and L)=Length of the orbit, right and left, measured from the point where the lachrymo-maxillary suture meets the frontal bone
 Lac O₁R and L=Right and left, from the point where the posterior lachrymal crest meets the fronto-lachrymal suture
 DC=Interorbital width from dacryon to dacryon
 G₁=Length of the palate, from the tip of the posterior nasal spine to the intersection of the median sagittal plane and an imaginary line tangential to the inner alveolar margin of the middle incisors
 G₂=Breadth of the palate between the inner alveolar walls of the second molars
 G₁'=Shorter length of the palate excluding the spine, measured from the base of the posterior spine
 EH=Height of the palate, taken with Pearson's uraniscometer in the median line between the second molars. The measurements were repeated with a more accurate instrument supplied by P. Hermann of Zurich
 fml=Length of the foramen magnum from opisthion to basion
 fmb=Breadth of the foramen magnum
 100 B/L=Cranial index
 100 H'/L=Height-length index
 100 B/H'=Breadth-height index
 100 (B-H')/L=Breadth-height-length index
 OcI=S₃/S'₃=Occipital index (see M. L. Tildesley, 1921a)
 100 G'H/GB=Facial index
 100 NB/NHR=Nasal index
 100 NB/NH'=Nasal index
 100 O₂/O₁=Orbital index, right and left
 100 O₂/O₁'=Orbital index, right
 100 O₂/Lac O₁=Orbital index, right
 100 G₂/G₁=Palatal index
 100 G₂/G₁'=Palatal index
 100 EH/G₂=Palatal height-breadth index
 100 fmb/fml=Index of the foramen magnum
 A ∠=Alveolar angle
 B ∠=Basion angle
 N ∠=Nasion angle
 P ∠=Profile angle
 Pros. P ∠. The angles A, B, N were measured with a protractor from the facial triangle which was constructed from the measurements LB, GL, and G'H. The alveolar P angle is the angle which the Frankfort horizontal plane forms with a line joining nasion and alveolar point. This is the Frankfort profile angle. The alveolar point is the lowest point of the alveolar margin, between the two upper central incisors. The prosthion P ∠ is formed by the Frankfort horizontal plane and the nasion-prosthion line. Prosthion is the foremost point in the mid-sagittal line. The instruments used for measuring the P ∠ and the prosthion P ∠ were Mollison's craniophore and the stivgoniometer

For comparative studies with measurements given by other observers the palatal length should be measured in two ways; namely, with and without the posterior spine. The latter is the more reliable measurement because the spine is often damaged. It seems preferable to measure the palatal breadth internally, though some writers quote the external measurement, which includes the breadth of the molars on both sides of the palate. The teeth are, of course, part of the palate, yet there is some justification for arguing that the size of the teeth should be a separate observation and that the true palatal width is G_2 , taken internally between the second molars. The depth of the palate is a useful measurement for comparative study, but few observers record this measurement.

Measurements of the foramen magnum have been made in deference to custom, but evidence suggests that they are of slight value in making racial comparisons (Hambly, 1940, p. 249).

The occipital index (Tildesley, 1921a) should be more generally used as a measure of the occipital bulge. A low index designates a bulging occiput, and on the contrary a high index implies a flattened occiput. The index expresses a proportion between the curve from lambda to opisthion and the chord between those two points. This index will be of service in studying the bulging of the occiput in deformed skulls from Malekula in which a frontal pressure applied during infancy has forced the occiput outward.

Students who use Martin's *Lehrbuch* (1928, vol. 2, pp. 639-643) are acquainted with the astonishing number of internal and external angles that can be measured on a human skull. Of all these the prosthion angle measuring the slope and prognathism of the face, and the angles of the facial triangle seem to be most important because they determine the physiognomy of the living. Many writers do not measure the A, B, N angles of the facial triangle, but Hrdlička always records G'H, LB, GL, which are the three sides of the facial triangle. One has only to construct the triangle from these data and then measure the angles with a protractor. The reason for taking a P angle and a prosthion P angle is the provision of data for comparative study. Some observers take the former angle, some prefer the latter. The difference between the two angles was small in a series of 124 male skulls from New Guinea. The average P angle was 82.8 ± 0.21 , and the prosthion P angle was 80.4 ± 0.22 . For 70 females the difference was rather less since the respective averages were 81.8 and 80.4 degrees (Hambly, 1940, p. 221).

In the tables of individual measurements for male and female skulls of Ambrym given in an appendix to this publication a column showing weights of skulls has been included. A great many workers do not record data of this kind, and I regret that the weights of skulls from New Guinea were not taken. The data taken subsequently on other Melanesian samples suggest that the weight of the skull is a useful criterion of sex, and possibly also of local differentiation among Melanesians. If more data were available one might find that the weight of the skull provided a significant difference between racial samples.

INSTRUMENTS USED

The instruments used for measuring skulls from Ambrym were the same as those employed for measuring skulls from New Guinea (Hambly, 1940), with the following exceptions:

The instrument now used for drawing contours is one made by Sergi, who has published several articles on its use, as well as drawings and photographs of the method of mounting (S. Sergi, 1926, 1927, 1929). There is no reason to believe that the contour drawings of skulls from Ambrym are not strictly comparable with those of other regions, made with different types of instruments devised for this kind of work. The literature on contour drawings and their technique are summarized (Hambly, 1940, p. 243) and to these items may be added a contribution of Black (1928). My method of drawing the sagittal contours of Ambrym is a modification of the usual biometric procedure since the parts of the skull below the Frankfort plane have been omitted, and comparison is confined to contours above that level.

When superimposing the vertical and horizontal contours the axes of the drawings are made to coincide, and for comparing sagittal contours the Frankfort planes and the auricular points are brought into coincidence. Adoption of the Frankfort plane has been criticized, and apparently with some reason, by Pycraft (1925), Ashley-Montagu (1927), and Phelps (1932). Pycraft is over-critical in describing the Frankfort plane as "useless" and "misleading"; his drawings do, however, show the value of the meato-nasion line in lifting the whole of the cranial portion of the skull above the datum line. Ashley-Montagu (1927) proposed a new orientation on the nasion-porion line "which orientation provides a relatively exact and uniform position wherein a skull may be placed with the minimum of labor and the maximum degree of accuracy and utility." A contribution by Phelps (1932) makes a detailed statistical study of the

variability in position of homologous points of a series of skulls under different methods of orientation. A considerable bibliography is cited.

Phelps (1932, p. 95) refers to a superposition of contours in which no base lines or planes are considered, and the attempt is made to bring as many points as possible into superposition along the curves. "The fitting of one contour to the other is by a trial and error method with visual check of results." This type of superposition has accordingly been used for descriptive rather than metric purposes; however, it has the merit of considering to some extent the variability of the contour as a whole. Students who prefer these methods can readily make tracings of the drawings given here and readjust them to new planes.

For measuring the P and prosthion P angles on skulls from New Guinea (Hambly, 1940, p. 96) the stativgoniometer was used. Martin (1928, vol. 2, p. 593, fig. 272) gives a photograph, but for measuring these angles on the skulls from Ambrym the ansteckgoniometer (Martin, 1928, vol. 2, p. 593, fig. 274) was employed. Measurements can be made by the latter instrument in time far less than that required for use of the stativgoniometer. The ansteckgoniometer is probably more accurate because only one adjustment and one scale reading are necessary, whereas the stativgoniometer requires two adjustments and three readings. The following table indicates the closeness of the readings taken with the two instruments.

MEASUREMENT OF P AND PROSTHION P ANGLES WITH TWO INSTRUMENTS

Skull number	STATIVGONIOMETER		ANSTECKGONIOMETER	
	P angle	Pros. P angle	P angle	Pros. P angle
43377	86.2	84.5	82.3	82.5
	84.5	82.6	83.0	82.7
	84.0	83.5	83.2	83.0
43369	80.7	79.2	80.0	77.0
	80.9	78.5	78.0	76.8
	82.5	76.3	77.3	76.0
43370	85.1	85.0	83.0	84.0
	84.9	85.0	82.8	82.8
	84.5	82.5	83.0	82.7
Average	83.7	81.9	81.4	80.8
	±0.40	±0.67	±0.49	±0.67

The readings were taken three times on each of three skulls. Probably in a longer series of measurements the averages obtained with the two different instruments would be closer than those given in this experiment.

During measurement of skulls from New Guinea a test of accuracy and consistency was made with two instruments for measuring depth of palate. My use of the older uraniscometer has been discontinued and the work is done with Hermann's palatometer (fig. 7).

CRANIAL CAPACITIES

Since publishing *Craniometry of New Guinea* a little more work on the technique of measuring cranial capacities has been accomplished.

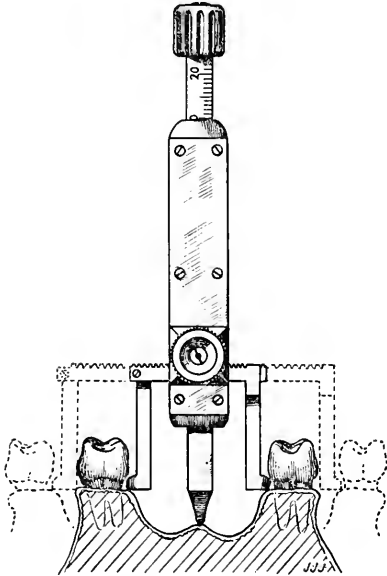

FIG. 7. The palatometer, used for measuring depth of palate. If carefully adjusted this is probably the most accurate instrument available for the purpose. For measuring palatal depth the adjustment is made between the second molars. The sliding rod is depressed until the lower point touches the palate. Reading on the scale then gives palatal depth.

The table given below makes a study of the capacities obtained for eleven skulls, which Dorsey measured with shot in the year 1897.

CAPACITIES OF NEW GUINEA SKULLS

Measured with No. 8 shot (Dorsey); with mustard seed (Hamby)

Skull number	With shot	With seed	Difference in cc.	Percentage difference
43561	1515	1424	91	6.0
43571	1415	1351	64	4.5
43566	1390	1324	66	4.7
43557	1545	1459	86	5.6
43569	1275	1207	68	5.3
43567	1275	1208	67	5.2
43560	1345	1289	56	4.2
43556	1060	1044	16	1.5
43565	1170	1088	82	7.0
43558	1345	1266	79	5.9
43559	1365	1275	90	6.6
Averages	1336.4 ±27.2	1266.8 ±24.5	69.5 ±4.1	5.1 ±0.28

I remeasured with mustard seed and have tabulated the differences, which range from 91 cc. to 16 cc. We must conclude that, on the average, a measurement with shot gives a resulting cranial capacity about 5.1 per cent higher than that obtained by use of mustard seed. Many years ago Turner (1884, vol. 10, No. 4, pt. 1, p. 9) came to the conclusion that Broca's method of measuring cranial capacities with shot gave a result 6.9 per cent higher than one which would be obtained by use of water.

A student who consults the *Thesaurus craniorum* (Davis, 1867) will find that the data relating to cranial capacities are apparently incomparable with those taken with mustard seed, for Davis used fine white sand. Fortunately, however, he states the specific gravity of the sand, and this information enabled me to obtain a sand of exactly this specific gravity through the kindness of the Department of Geology of Chicago Natural History Museum. Experiments with a water-tight skull (*crâne étalon*) are explained below in detail and indicate: (1) That use of fine shot known as No. 8 gives a cranial capacity about 5.4 per cent too high. (2) The fine white sand of specific gravity 1.425, used by Davis, gives a capacity 8.4 per cent too high. Fine mustard seed, if closely packed in the skull, gives about the same capacity as that obtained by use of water.

My experience is that so much time is spent in plugging a skull to make it watertight that one had better stop the holes with absorbent cotton and use fine mustard seed. The method of employing a rubber bag which was placed within the skull and filled with water (Bartels, 1896; Matthews, 1898) is, I believe, seldom used today.

The essentials of the seed method are a careful packing of the skull, and employment of a constant, which has previously been worked out to show relationship between the weight and the volume of the seed used. The simplest method consists of the following stages:

- (1) Weigh the empty skull.
- (2) Weigh the skull full of tightly packed seed.
- (3) Subtract (1) from (2) and so get the weight of seed.
- (4) Multiply the weight of seed by the constant found by experiment with a *crâne étalon*, and the result will be the capacity in cubic centimeters.

This is much more accurate and quicker than pouring the seed from the skull into a graduated cylinder and tamping it carefully therein. Packing the skull is sufficiently tedious without performing a second operation of like kind.

The following table gives the details of an experiment performed with a *crâne étalon* in order to find the differences in measured capacity when water, mustard seed, shot, and sand were used in turn.

COMPARATIVE CRANIAL CAPACITIES OF A SKULL, DETERMINED BY
USE OF DIFFERENT MATERIALS

WATER			MUSTARD SEED			SHOT			SAND		
Spec. grav.	Weight in gms.	Capacity in cc.	Spec. grav.	Weight in gms.	Capacity in cc.	Spec. grav.	Weight in gms.	Capacity in cc.	Spec. grav.	Weight in gms.	Capacity in cc.
1.000	1310	1310	0.7806	1028.0	1317	6.599	9240.9	1400	1.602	2277.0	1421.3
	1310	1310		1026.0	1314		9104.0	1380		2293.0	1431.3
	1325	1325		1026.2	1315		9085.6	1377		2285.5	1426.6
Averages	1315	1315		1026.7	1315		9143.5	1386		2285.2	1426.4

The eye must note comparative results; standard deviations for such a small number of observations are of little value.

Not all workers would agree that measuring skull capacity by this method is a repayment for the time and labor expended; but I believe that the trait is worth investigating since it may be a criterion of sexual, geographical, and racial differences if the measurement is performed with extreme care.

Remeasuring of the capacity of fifty New Guinea skulls showed that in the hands of the same experimenter the *average* capacities obtained could be as close as 1258 cc. (first experiment) and 1257 cc. (second experiment), though of course the discrepancies in measurement were greater for certain individual skulls (Hambly, 1940, p. 116).

The table below indicates the proximation of results obtained by two trained assistants RT and HS, who worked independently in measuring 47 skulls by the mustard seed method just described.

TABLE OF DIFFERENCES IN CRANIAL CAPACITY
FOUND BY TWO WORKERS

Differences in cc.	Number of skulls showing difference	Differences in cc.	Number of skulls showing difference	Differences in cc.	Number of skulls showing difference
0	5	4	5	8	1
1	7	5	4	9	4
2	4	6	2	10	1
3	8	7	6		

In each of five instances the experiments gave no difference; for each of seven skulls the difference obtained was only one cubic centi-

meter; the greatest difference was 10 cc. for just one skull. The average capacity obtained by RT was 1267.4 cc. and by HS 1268.8 cc.

One must admit, of course, that the method is tedious and the use of a formula for calculating average cranial capacity of a series of skulls is desirable. The cranial capacity of 124 New Guinea male skulls was 1280 ± 6.87 cc. according to experiment with mustard seed (Hambly, 1940, p. 94) and 1277 ± 5.84 by the formula of Isserlis (1914, p. 189), a very close approximation.

For the 19 male skulls of Ambrym the measured capacity is 1318.7 ± 15.46 , and by the formula of Isserlis the capacity is 1301.7 ± 14.9 , so giving a difference of only 17 cc., which is not significant. If a student does not wish to find cranial capacities experimentally, there is some evidence to show that he will not make a serious error in using the formula of Isserlis

$$C = .0003849 \times BLH + 96 \pm 65 / \sqrt{N}$$

to estimate the average cranial capacity of a series of male skulls from Melanesia.

STATISTICAL METHODS

The statistical methods used in this article are those generally accepted for this kind of work. The tables at the end of the book show the probable errors of the averages worked out by a formula (Yule, 1937, p. 178).

For comparing two averages to find whether there is a significant difference the formula

$$M_1 - M_2 > 3 \sqrt{(PE_1)^2 + (PE_2)^2}$$

has sometimes been employed, or use has been made of the nomogram, a geometrical device explained by Andrews (1939).

If, by these methods, the difference between two averages is shown to be not significant we may say that, mathematically speaking, the averages might have been drawn from the same population.

The coefficient of racial likeness for expressing a relationship between two series of averages for traits measured on two series of skulls was explained in dealing with measurements on crania from New Guinea (Hambly, 1940, pp. 127, 244-246) where literature was cited and some objections to the coefficient were discussed. Unfortunately, we have only 19 male skulls in the Ambrym series; therefore, despite the large number of traits measured, there might be an objection to the use of the CRL on the grounds that our sample is too small for comparison with some of the larger series that are available for Melanesians, Australians, Polynesians, and Negroes.

We can, however, compare two series of cranial measurements by noting how many traits have average values whose differences may be described as not significant.

This kind of comparison was found to be useful in *Craniometry of New Guinea* (p. 263). Out of 32 traits measured on Australian and on Negro skulls, 20 of the averages showed no significant difference. In other words the two series of skulls had a likeness ratio of 20:32. When the same Negro group was compared with a New Guinea series of skulls with respect to the same traits the likeness was 12:32. There was also a likeness of 12:32 when the same 32 traits were compared on adequate series of Negro and New Britain (Melanesian) skulls. We must not make a fetish of statistics, but one feels that such comparisons justify the labor involved, for they do give definite quantitative ideas which are a valuable supplement to impressions conveyed by photographs, descriptions, and the figures showing average measurements.

This method will be more fully explained in a later chapter where average measurements of skulls of Ambrym are compared with average measurements of skulls from New Guinea, Australia, East Africa, and Polynesia.

III. SEX DIFFERENCES IN AMBRYM SKULLS

In a previous chapter (pp. 4, 7) attention has been called to sex differences that are very pronounced, not only in skulls from Ambrym, but in all crania from Melanesia. The morphological sex differences are well illustrated in plates 1-30, but we wish to go further and discuss the biometrical value of those differences. Before doing so, however, some consideration should be given to the literature on this subject, though no attempt will be made to give a complete survey.

PROPORTION OF MALES TO FEMALES

The proportion of males to females in the cranial sample from Ambrym is 19:11. This fact alone would scarcely call for comment since the total number of skulls is small, and one would be right in assuming that the small excess of male skulls might be due to the random nature of the sampling; but when we note that the Museum's collection from New Guinea contains 124 male and only 70 female adult crania, and when we glance further at samples of skulls from many Melanesian islands (this work, p. 11) and observe the same kind of ratio, we are led to believe that the preponderance of male over female skulls is not a chance but is more probably an indication of excess of male over female population for the age groups (20-50 years) that comprise our survey.

When reporting on excavations at Pecos, Professor E. A. Hooton (1930) discusses the excess of male over female skeletons. He states that at one time he was inclined to attribute this disparity to the more enduring nature of male bones, and also to the possibility that female bones of somewhat masculine appearance had been classed as males. According to Hooton (p. 345) more male than female children are born in all populations, but the ratio of males to females declines through successive age periods.

This statement finds no support in statistics for Melanesian crania (this work, p. 11), where ratios of male to female skulls are given for age periods 20-30, 30-40, and 40-50 years. In the first age period the male to female ratio is 81:72. In the second period the ratio is 42:14, and for the last period 89:16. The ratio of males to females actually increases with advancing age periods.

Nevertheless, Hooton's statement respecting the declining ratio of males to females may be true for Melanesians, and perhaps the cranial material from that region would support the assertion if the skulls were taken from burial grounds. There is good reason to believe, however, that the Melanesian skulls in Chicago Natural History Museum are head-hunters' trophies and ancestral skulls ceremonially preserved. If we assume that males rather than females were victims in warfare and head-hunting expeditions, and also that a preference might be given to male heads for preservation as ancestral relics, we have a possible explanation of the excess of males over females in all age groups of our Melanesian crania.

So far as skeletal testimony is concerned, there can perhaps be no satisfactory conclusion respecting male to female ratios, unless large numbers of skulls and long bones are taken from cemeteries or from other sites that are in no way likely to yield a biased sample.

Our Melanesian sample is obviously open to bias through ethnological customs that might favor excess of males among the preserved crania, and one should not forget that, even in case of ceremonial burials, there may have been in mortuary customs some discrimination that has tended to misrepresent the true sex ratio of the living community.

LITERATURE ON SEX DIFFERENCES OF CRANIA

A brief study of morphological differences in crania of the sexes, if carried out by inspection of plates 1-30, might leave the impression that such comparisons are easy to make and that sexing a series of skulls is a simple matter. We can be assured, however, by consultation of the literature on this subject that the sex differentiation of skulls is not so facile as one might be led to believe from inspection of typical photographs of Melanesian male and female crania.

Borovansky (for references see Krogman, 1941), whose main observations are summarized in English (see Borovansky, 1936), examined 132 male and 115 female Czechoslovakian skulls in the Anatomical Institute of Charles University, Prague. He emphasizes the importance of the glabella and supraorbital ridges as distinguishing traits. He found these features to be absent in only 4 per cent of male skulls, but wanting in 66 per cent of female skulls. Large mastoids were recorded in 35.6 per cent of males, but in only 12.3 per cent of females. The external occipital protuberances were more marked in male skulls, but some exceptions had to be made. No important difference in the shape of the orbital borders was recorded.

Alveolar prognathism occurred in 3 per cent of males and 19 per cent of females. Cranial dimensions were consistently greater in the male series. Female skulls revealed a slightly higher cranial index, were slightly broader, had a higher nasal index, and a slightly higher orbital index.

Borovansky states that the majority of dimensions are more variable in male than in female skulls, and he makes the astonishing observation that the weight of the mandible and of the skull are quite unreliable for determining sex. If taken alone, any one trait is, of course, unreliable for this purpose, but in the collection of Melanesian skulls the weight of the male skull is almost invariably in excess of the weight of a typical female skull. In the Ambrym skulls in particular the male skulls are made ponderous by a heavy occipital torus.

Borovansky does, however, state, and I think with great truth, that our reliance on certain traits as determinants of sex should vary considerably according to the biological group (race) that is under observation.

Parsons and Keene (1919) state that the female skull is shorter in proportion to its breadth than the male skull, by 2 per cent. This difference is not fully accounted for by the greater development of the frontal sinuses in the male. The total facial index (nasion-menton in relation to bizygomatic) does not differ in the two sexes. Consideration of auricular heights in relation to maximum skull breadths indicates that the female skull, compared with the male, is lower in proportion to the width by 1 or 2 per cent. The average width of the female palate is 8 mm. narrower than that of the male. The bizygomatic width in relation to the maximum skull breadth gives an index that is 4 per cent greater in the male than in the female.

Wissler's (1927b) contribution indicates that study of sex differences in cranial forms is complicated by age and race. Males have the higher breadth-length index at birth and during the first year, but some time between birth and maturity females acquire the higher index. If this is true, then our comparison of cranial indices in male and female groups of the same race might be biased by an age factor. In other words, we ought to compare indices of males and females with due regard to age groups.

Change of head form in immigrants was studied by Boas (1912) and much discussion has focused about his data concerning change of head form in relation to environment. Pearson and Tippett (1924) concluded that between 8 and 20 years of age there was no significant

change in the shape of the head, and that the researches of Galton showed the same truth for cranial material ranging from 6 to 80 years of age. Considerable environmental differences in England appear to make no significant change in the shape of the head.

These are, of course, comforting thoughts to a student who feels discouraged by the number of variables that apparently affect the solution of any problem, especially when one is dealing with small samples. But craniometrists must still regard the alleged effect of environment on skull form as a possibility.

Discussions of the cranial index in relation to race, sex, and age have been continued by Stewart (1936), Fleure and Davies (1936), and Gladwin (1941). Stewart reviews the work of Poniatowski (1911) and gives a large bibliography relating to the study of cranial indices, but more from the point of view of race than sex and age.

Several classifications of head form are given as follows:

CLASSIFICATION OF CRANIAL INDICES

	Hyperdolicho:	Dolicho:	Meso:	Brachy:	Hyperbrachy:
Stewart.....	65-69.9	70.0-74.9	75.0-79.9	80.0-84.9	85.0-89.9
Old scheme.....	70.0	70.1-75.0	75.1-80.0	80.1-85.0	85.1
Fleure.....	72.5	72.5-78.5	77.5-81.5	81.5-85.1	85.1
Gladwin.....	73.49	73.5-80.49	80.5

A student who refers to the articles mentioned will, I believe, come to the conclusion that our best methods of studying sex differences in Melanesian skulls are (1) by comparison of contour drawings and photographs; (2) arithmetically, by sex ratios; (3) by recognizing that we are dealing with small samples, and we should for this reason consider whether the apparent differences between sex averages are significant; and (4) by considering the comparative variability of traits for males and females by tabulating coefficients of variation.

CONTOUR DRAWINGS

Contour drawings—horizontal, vertical and sagittal—drawn to natural size, give a quick visual impression of differences in size and outline between male and female skulls. The horizontal contours (facing pp. 38, 46, 54) show the female skull to be appreciably shorter than the male, but the outlines follow one another closely. The vertical contours (facing pp. 38, 46, 54) indicate that the female skull has a lower vault and is narrower than the male skull, but the almost parallel position of the contours indicates that the average outline of the female skull is very like that of the male. The sagittal

contours (facing pp. 38, 46, 54) show that the female skull is appreciably shorter and lower than the male skull, also that the glabella region in the latter is far more prominent.

SEX RATIOS: AMBRYM, NEW GUINEA, NEW BRITAIN

In the table of sex ratios (pp. 30, 31) we have a concise summary of the relationship of male to female average measurements for a large number of traits. It is possible to see at a glance how the sex ratios differ in samples of skulls from New Guinea, New Britain, and Ambrym. The arithmetical process of finding a sex ratio is simple; for example, the average cranial capacity of the male skulls is 1318.7 cc., and the average for the female skulls is 1183.5 cc. Therefore the sex ratio is $1318.7 / 1183.5 = 1.114$. The male skull has a capacity of rather more than 1.1 times the capacity of the female skull. Obviously, if the average measurement on male skulls is greater than the corresponding measurement on female skulls the figure expressing the sex ratio for that trait must be unity, followed by a decimal. If the two measurements, male and female, happened to be identical, then the ratio would simply be expressed by 1.000. Furthermore, if the average measurement for a trait on female skulls happened to be greater than the corresponding average measurement on male skulls, then the ratio would be less than unity; for example (table, p. 31), the sex ratio for the N angle on Ambrym skulls is 0.999. The actual measurements of this angle were 75.1° for female skulls and 75.0° for

SEX RATIOS OF MELANESIAN SKULLS
(1) New Guinea; (2) New Britain; (3) Ambrym

Locality	Capacity in cc.	L	B	B'	H'	LB	S ₁	S ₁ '	S ₂
1	1.110	1.043	1.038	1.053	1.025	1.031	1.038	1.041	1.043
2	1.063	1.066	1.049	1.037	1.061	1.065
3	1.114	1.057	1.044	1.044	1.027	1.069	1.046	1.051	1.027
	S ₂ '	S ₃	S ₃ '	S	GLU	U	BQ'	GB	J
1	1.048	1.035	1.029	1.036	1.047	1.040	1.037	1.054	1.067
2	1.055	1.052	1.062	1.079
3	1.025	1.074	1.028	1.049	1.062	1.051	1.043	1.112	1.117
	G'H	GL	NHR	NHL	NH'	NB	O ₁ R	O ₂ R	O ₁ L
1	1.054	1.031	1.057	1.057	1.058	1.033	1.036	1.024	1.036
2	1.084	1.063	1.070	1.048	1.031
3	1.109	1.090	1.087	1.097	1.103	1.079	1.059	1.003	1.072
	O ₂ L	O ₁ 'R	O ₁ 'L	Lac O ₁ R	Lac O ₁ L	DC	G ₁	G ₂	G ₁ '
1	1.027	1.031	1.032	1.029	1.032	1.056	1.033	1.061	1.017
2	1.058	1.067
3	1.028	1.073	1.076	1.053	1.044	1.113	1.108	1.061	1.130

males. The sex ratio is $75.0/75.1=0.999$, which means that male skulls have an average N angle which is 0.999 of the corresponding angle on female skulls; that is, practically equal to the average N angle of the female skulls.

When studying the table of sex ratios we are trying to clarify two points of interest: (1) Are sex ratios much the same for the samples from New Guinea, New Britain, and Ambrym? (2) Are male measurements invariably greater than those of females?

On the whole the table emphasizes the fact that sex ratios are much the same for the three Melanesian regions under discussion. This statement is easily verified by glancing through all the ratios and noting that they almost invariably agree in the first place of decimals, and are usually close in the second place. The third place of decimals can hardly be considered of practical importance.

An answer to the second question, respecting the excess of average male measurements over average female measurements, is best summarized as follows:

- (1) Ratios of cranial capacities and weight of the skull show the male value to be always greater.
- (2) Out of 94 sex comparisons of linear measurements, 92 male values are in excess of female values. An unimportant exception occurs in the comparison of dimensions of the foramen magnum in skulls from Ambrym. For the breadth of this aperture the sex ratio is 1.000, which means that the average measurements on male and female skulls are identical. The sex ratio for the measurements of length of the foramen

SEX RATIOS OF MELANESIAN SKULLS—*Continued*

(1) New Guinea; (2) New Britain; (3) Ambrym

Locality	EH	fml	fmb	$\frac{100B}{L}$	$\frac{100H'}{L}$	$\frac{100B}{H'}$	$\frac{100(B-H')}{L}$	OcI
1	1.154	1.050	1.033	0.996	0.985	1.008	1.050	0.990
2		1.031	1.045	0.984	0.996	0.998		0.983
3	1.179	0.991	1.000	0.990	0.974	1.012	0.833	0.930
	$\frac{100G'H}{GB}$	$\frac{100NB}{NHR}$	$\frac{100NB}{NH'}$	$\frac{100O_2R}{O_1R}$	$\frac{100O_2R}{O_1'R}$	$\frac{100O_2R}{LacO_1R}$	$\frac{100G_2}{G_1}$	$\frac{100G_2}{G_1'}$
1	0.997	0.990	0.983	0.993	1.016	1.016	1.015	1.026
2	1.025		0.975		0.974			
3	0.990	0.993	0.977	0.948	0.938	0.961	0.958	0.933
	$\frac{100EH}{G_2}$	$\frac{100fmb}{fml}$	A Z	B Z	N Z	P Z	Pros. PZ	Weight in gms.
1	1.090	0.984	0.996	1.018	0.993	1.012	1.000	
2		1.013	0.998		0.991	1.012		
3	1.102	1.007	0.988	1.023	0.999	0.995	0.996	1.366

magnum is 0.991, which indicates that measurement for the females is the merest trifle in excess of the corresponding average value for males.

- (3) Sex ratios for angles approach very close to unity, but out of 13 ratios, eight indicate that the measurements on female skulls are very slightly in excess of those on male skulls.
- (4) Consideration of indices shows that ratios are very close to unity, but the index for females tends to be slightly higher than that for males. Out of 38 indices, 26 are a little higher for females. But the differences in indices are so small that we must note a tendency rather than an established fact.

The point of morphological interest arising from this summary may be presented by asking why all linear measurements for males are greater than those for females? But, on the contrary, why are the sex ratios for *indices* and *angles* so close to unity?

To give a satisfactory answer to this question we must emphasize the fact that within a biological group (in this case Melanesian) certain definite skull traits are characteristic of the members, both male and female. The fact that average measurements for male skulls are greater than corresponding measurements for female skulls is a condition that affects size only. But, on the contrary, indices (proportions) and angles which determine facial contours are the morphological foundation of what we have been accustomed to describe as "race."

Phylogenetic processes are concerned with the preservation as well as with the crossing of cranial types. A Melanesian type of head form and physiognomy can be well preserved if proportions and angles are practically the same in male and female skulls, despite the fact that male skulls are larger than female skulls.

All this is arithmetically expressed by stating that 95 sex ratios for size have an average of 1.059, whereas the sex ratios for 51 indices and angles (race determinants) are so close to unity that the average value of the ratio is 0.993. For size measurements the average sex difference is about 5.9 per cent, but for indices and angles the sex difference is only 0.7 per cent.

MAGNITUDE OF SEX DIFFERENCES

A question arises as to the significance of apparent sex differences in measurement. Thus far we have accepted as valid any arithmetical difference between the averages for male and female traits. But

our Ambrym sample in particular is a small one, and possibly some differences arise from the nature of the sampling. The tables of Δ/P_{Δ} values (p. 34) are a criterion of the significance of the sex differences, and by means of these values one may judge the relative magnitude of these differences.

The formula generally used for comparing two average measurements in order to judge whether the difference is significant or not is

$$M_1 - M_2 > 3\sqrt{(PE_1)^2 + (PE_2)^2}.$$

Expressed in words the formula indicates that if the difference of the means is greater than three times the square root of the sum of the squares of the probable errors of both means, then the difference between those means is significant. The Δ/P_{Δ} value is found by dividing the difference between the means by the value of

$$\sqrt{(PE_1)^2 + (PE_2)^2}.$$

The table of these Δ/P_{Δ} values (upper, p. 34) should be considered in two sections: (1) Measurements of line, and (2) measurements of angles and the value of indices.

There are 40 Δ/P_{Δ} values recorded for sex differences of indices and angles, and of these 34 are definitely "not significant."

Analysis of this table therefore confirms the results previously obtained by a consideration of sex ratios. Sex differences expressing size, for example, caliper measurements, cranial capacities, and weights of skulls, are true differences; but, on the contrary, there are not-significant sex differences in the angles, and of sex differences in indices only six out of 30 are likely to be significant.

This likeness of angles for male and female skulls, together with the close resemblance of indices, preserves almost a complete identity of cranial and facial appearance in the two sexes.

A study of sex differences that are significant shows, of course, that some traits are more reliable than others as criteria when sexing skulls. Since the Ambrym sample is small let us base conclusions on a survey of the New Guinea data only. The table (lower, p. 34) is an arrangement of the sex differences in descending order of magnitude according to the evidence of their Δ/P_{Δ} values.

The previous statement, that sex distinctions that are characteristic of one series of skulls may not have the same value for sexing skulls of a different race, must be borne in mind. But, so far as the long New Guinea series is concerned, one may deduce that GLU (measuring size of glabella), J (measuring bizygomatic width), and

CRANIOMETRY OF AMBRYM ISLAND

DIFFERENCES IN Δ/P_{Δ} VALUES BETWEEN AVERAGE MEASUREMENTS ON
MALE AND FEMALE SKULLS

Upper figures for Ambrym, lower for New Guinea

Capacity in cc.	L	B	B'	H'	LB	S ₁	S ₁ '	S ₂
5.4	5.9	6.1	4.7	2.7*	6.4	3.5	4.3	1.8*
13.8	13.5	10.2	14.1	6.0	6.8	7.7	9.1	7.9
S ₂ '	S ₃	S ₃ '	S	GLU	U	BQ'	GB	J
1.8*	4.7	3.2	4.5	8.3	6.0	4.3	11.2	15.7
9.7	5.1	5.1	11.1	17.6	16.4	10.2	10.7	15.6
G'H	GL	NHR	NHL	NH'	NB	O ₁ R	O ₂ R	O ₂ L
5.9	8.5	5.1	7.0	6.6	4.3	5.6	0.2*	4.3
7.5	5.8	8.7	8.7	6.7	4.7	9.3	4.0	7.6
O ₂ L	O ₁ 'R	O ₁ 'L	Lac O ₁ R	Lac O ₁ L	DC	G ₁	G ₂	G ₁ '
1.7*	8.2	5.1	3.5	3.9	5.1	6.2	3.7	6.7
4.4	4.7	5.6	4.9	5.0	6.9	4.5	8.7	2.3*
EH	fml	fmb	$\frac{100B}{L}$	$\frac{100H'}{L}$	$\frac{100B}{H'}$	$\frac{100(B-H')}{L}$	OcI	
3.2	0.5*	0.0*	1.0*	3.6	1.2*	2.4*	5.5	
7.0	6.4	4.1	0.9	3.3	1.4*	0.0*	1.4*	
$\frac{100G'H}{GB}$	$\frac{100NB}{NHR}$	$\frac{100NB}{NH'}$	$\frac{100O_2R}{O_1R}$	$\frac{100O_2R}{O_1'R}$	$\frac{100O_2R}{LacO_1R}$	$\frac{100G_2}{G_1}$	$\frac{100G_2}{G_1'}$	
0.5*	0.4*	0.8*	3.9	4.6	2.3*	1.7*	2.6*	
0.3*	1.1*	1.0*	1.0*	1.7*	0.4*	1.6*	2.7*	
$\frac{100EH}{G_2}$	$\frac{100fmb}{fml}$	A ∠	B ∠	N ∠	P ∠	Pros. P∠	Weight in gms.	
1.9*	0.4*	1.0*	1.4*	0.1*	0.4*	0.3*	7.6	
4.4	2.0*	0.8*	2.2*	1.3*	2.6*	0.0*	...	

* Not-significant differences in sex measurements.

The table clearly shows that sex differences are principally those of size. Indices (proportions) and angles show no significant difference; thus the racial pattern is preserved in the two sexes.

TABLE INDICATING MAGNITUDE OF SEX DIFFERENCES IN NEW GUINEA SKULLS

Δ/P_{Δ} Value	Trait	Δ/P_{Δ} Value	Trait	Δ/P_{Δ} Value	Trait	Δ/P_{Δ} Value	Trait
17.6	GLU	9.7	S ₂ '	7.0	EH	5.0	Lac O ₁ L
16.4	U	9.3	O ₁ R	6.8	LB	4.9	Lac O ₁ R
15.6	J	9.7	S ₂ '	6.7	NH'	4.7	O ₁ 'R
14.1	B'	8.7	G ₂	6.4	fml	4.7	NB
13.8	C	8.7	NHL	6.9	DC	4.5	G ₁
13.5	L	8.7	NHR	6.0	H'	4.4	100 EH/G ₂
11.1	S	7.9	S ₂	5.8	GL	4.4	O ₂ L
10.7	GB	7.7	S ₁	5.6	O ₁ 'L	4.1	fmb
10.2	B	7.6	O ₁ L	5.1	S ₃ '	4.0	O ₂ R
10.2	BQ'	7.5	G'H	5.1	S ₃	3.3	100 H'/L

B' (measuring minimum frontal diameter) are very important as sex criteria; so also are cranial capacity and length of skull. The breadth of the face, the greatest breadth of the skull, and the vertical arc over bregma show marked sex distinctions.

So one may glance down the table, noting once more that there are no differences in angles, but right at the bottom of the table the relation of the length of the skull to the height is shown to be a sex trait which according to the Δ/P_{Δ} value of 3.3 is just significant. This is the only *index* figure that appears in the table of significant sex differences.

In a desire for arithmetical backing for observations of sex differences the presence of tendencies which are not statistically verifiable should not be overlooked.

I believe, for instance, that the average orbital index of the female skull is greater than that of the male; in other words, the females have rounder eye sockets (with thinner margins). But, though the more pronounced roundness of female orbits can be noticed in many skulls, a statistical comparison of the average orbital indices sometimes shows that the difference is not significant, yet the tendency is definitely there. In one example (Ambrym; table, p. 34) the extra roundness of the female orbit is, however, statistically demonstrable. The Δ/P_{Δ} values are 3.9 for 100 O_2R/O_1R and 4.6 for 100 $O_2R/O_1'R$. Again, male skulls of Ambrym have an exceptionally heavy occipital torus, and the Δ/P_{Δ} values of the two occipital indices, male and female, show a significant difference. The same sex tendency is present in male and female skulls from New Guinea, but the significance of the difference between the two occipital indices is not mathematically demonstrable.

For the three samples, New Guinea, New Britain, and Ambrym, the average cranial indices indicate that females are slightly more round-headed than males, but this is a tendency which is not statistically demonstrable because the differences are so small.

In studying sex differences of the skulls one should consider all evidence: contours, photographs, statistical demonstration, and trends of figures which show tendencies that are not actually demonstrable by mathematical methods.

We ought now to consider which of the measured traits have the greatest variability in Melanesian males and females respectively. And for this purpose our selection should be the largest sample available, namely 124 male and 70 female skulls from New Guinea.

The coefficient of variation is calculated from the formula

$$V = \frac{100 \sigma}{M},$$

and the probable error of the coefficient is

$$\frac{V}{2N} \times 0.674489,$$

where σ is the standard deviation for the measurements of the trait, M is the mean measurement, and N is the number of measurements of that trait.

VARIABILITY OF TRAITS IN THE SEXES

When studying the variability of skull traits for both males and females one would like to know whether the variability is greater in males or females, and whether the variability of the traits in a Melanesian sample is a close approximation to the variability of corresponding traits in skulls of other racial groups. These are, of course, two distinct problems, so let us consider firstly the variability of traits by sex only.

The table showing variability of skull traits (p. 37) gives a list of 36 coefficients of variation for measurements, angles, and indices of skulls of both sexes from New Guinea. Pearson and Davin (1924, p. 342), when discussing correlation and variability of parts of the skull, mention some circumstances that might make a comparison of variability of indices and angles by their standard deviations more reliable than a comparison made by means of coefficients of variation; but after comparing results obtained by both methods the caution seems to me to be of more theoretical than practical importance. Consultation of the table on page 39 shows that six out of six indices, and four out of four angles, have a higher variability in the male Egyptian skulls, no matter whether our criterion is standard deviations or coefficients of variation.

The coefficients of variation (p. 37) from Hambly's New Guinea data (1940) are given with their probable errors, but there is no need to make a statistical comparison of each pair of coefficients in relation to their respective probable errors. The information sought may be derived from the table by general inspection of the coefficients, which are arranged in descending order of magnitude.

We notice in the first place that the arrangement of coefficients for the various traits does not exactly correspond for the two sexes; but the disparities are not considerable, and there is a noticeable agreement in the order of arrangement.

VARIABILITY OF SKULL TRAITS
Melanesians of New Guinea: 124 Males, 70 Females

COEFFICIENT OF VARIATION: MALES		COEFFICIENT OF VARIATION: FEMALES	
Trait	Trait	Trait	Trait
EH.....	17.40±0.83	EH.....	15.30±0.96
100EH/G ₂	16.10±0.77	100EH/G ₂	15.17±0.96
100G ₂ /G ₁ '.....	9.58±0.45	100NB/NHR	8.92±0.50
100NB/NHR	8.22±0.35	DC.....	8.84±0.50
G ₂	8.45±0.36	100G ₂ /G ₁ '.....	8.05±0.48
DC.....	8.77±0.38	B Z.....	7.68±0.47
C.....	7.81±0.33	G'H.....	7.54±0.46
G ₁ '.....	7.74±0.36	100 O ₂ /O ₁ (R)	7.23±0.42
fmb.....	7.45±0.35	LB.....	3.99±0.24
fml.....	7.10±0.33	H'.....	3.78±0.23
NHR.....	6.87±0.30	B.....	3.64±0.21
G'H.....	6.69±0.29	O ₁ R.....	3.52±0.20
NB.....	6.60±0.28	B'.....	3.36±0.19
B Z.....	6.20±0.29	BQ.....	3.27±0.19
Ocl.....	6.14±0.28	L.....	3.01±0.17
100B/L.....	5.67±0.24	S.....	2.94±0.19
100 O ₂ /O ₁ (R).....	5.51±0.24	GLU.....	2.33±0.13
O ₂ R.....	5.32±0.23	U.....	2.16±0.12
		100B/H'.....	5.58±0.34
		fmB.....	6.87±0.45
		NHR.....	6.83±0.39
		fml.....	6.83±0.44
		G ₂	6.72±0.39
		C.....	6.55±0.37
		O ₂ R.....	6.36±0.36
		Ocl.....	6.17±0.40
		100B/H'.....	5.58±0.34

At the top of the list are traits with the highest variability, namely, the depth of palate and the palatal index, and in this division of high coefficients (six and upward) are palatal and nasal measurements. In the lowest group of coefficients are those for the circumference of the skull; the transverse and sagittal arcs; the cranial height, length and breadth; and the length of base of the skull.

Out of 36 New Guinea traits considered, the coefficient of variation is greater for males in 21 instances; and, even allowing that some of the differences between male and female coefficients may be so small that they are not statistically significant, the figures of comparison clearly indicate greater variability of the male skulls.

VARIABILITY OF TRAITS IN RELATION TO RACE

One naturally asks whether the coefficients of variation for traits of New Guinea skulls show any pronounced divergence from those pertaining to skulls of other races. Do the size, the range, and the classification in high, medium, and low groups differ considerably in a series of Egyptian or Old English skulls as compared with the New Guinea series? Within each racial group do males or females claim the greater number of traits with higher coefficients?

In order to answer these questions relating to the racial comparison of coefficients of variation a table has been prepared in which the coefficients for skulls from New Guinea, Egypt, and Hythe (England) are arranged in parallel columns. The data for skulls of the Egyptian "E" series are from Pearson and Davin (1924) and those for Hythe are given by Stoessiger and Morant (1932). In this table (p. 39) we are not concerned with probable errors and their use in making detailed comparison of coefficients, but only with comparisons of a general kind. If the table is consulted vertically we note that the range of coefficients for the three ethnic groups, as well as for the sexes, is closely comparable; for example, the coefficient for the horizontal circumference of the skull above glabella is in all instances 2-3 in value, the precise range being 2.98-2.33. At the head of each column is the highly variable trait EH, depth of palate, which has coefficients ranging from 15.30-23.25 in value.

The groups low, medium and high, which are obtained by dividing the columns horizontally, show close correspondence in the traits they contain; for example, U, H', BQ', S, LB, L, J, and B have coefficients of 2-4 in value for all three racial samples in the group.

The coefficients in the high group, valued at six and above, always pertain to the palate, the nose, the cranial capacity, the

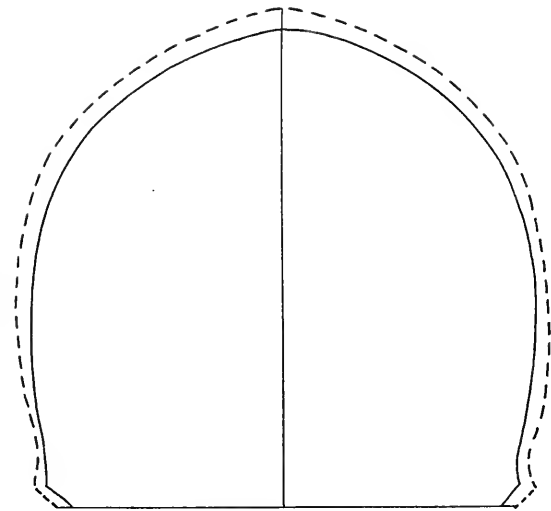

AVERAGE VERTICAL CONTOURS
Ambrym skulls: 19 males, 11 females (male contour in broken line)

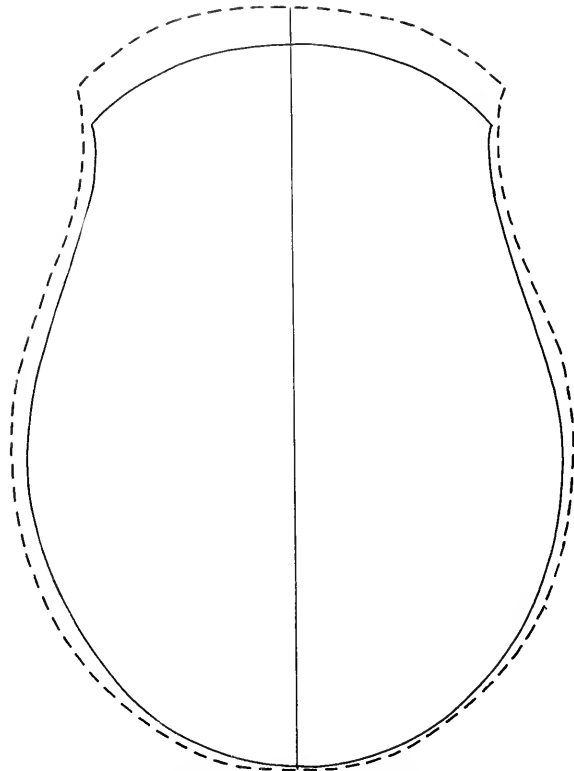

AVERAGE HORIZONTAL CONTOURS
Ambrym skulls: 19 males, 11 females (male contour in broken line)

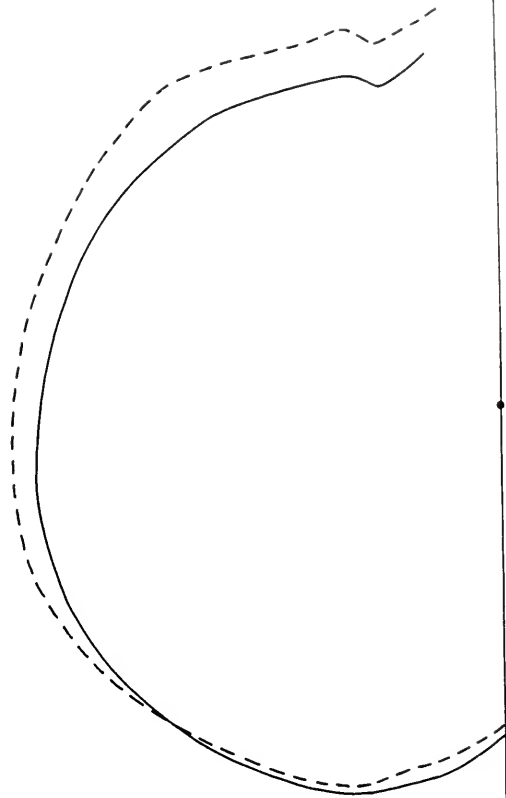

AVERAGE SAGITTAL CONTOURS
Ambrym skulls: 19 males, 11 females (male contour in broken line)

RACIAL VARIABILITY: COEFFICIENTS OF VARIATION OF SKULL TRAITS
 New Guinea, Egyptian, Hythe (Old English)

Trait	MALES			FEMALES		
	New Guinea	Egyptian	Hythe	New Guinea	Egyptian	Hythe
EH	17.40	23.25	15.30	21.73
$\frac{100}{EH}$	16.10	22.60	15.17	19.88
$\frac{G_2}{G_1}$	9.58	8.90	8.92	7.83
$\frac{100}{NB}$	8.22	8.08	7.50	8.84	7.90	8.20
NHR	8.45	6.78	7.05	8.05	6.83	5.59
G_2	8.77	9.71	7.68	10.70
DC	7.81	7.89	7.53	7.54	7.08	7.47
G_1'	7.74	6.69	5.86	7.23	6.06	6.34
fmb	7.45	7.18	7.45	7.02	6.96	6.36
fml	7.10	6.95	6.86	7.01	6.37	6.25
NHR	6.87	5.65	5.76	6.87	5.31	4.75
$G'H$	6.69	5.90	5.49	6.83	5.64	5.25
NB	6.60	7.27	6.71	6.83	6.98	7.63
B \angle	6.20	6.34	5.75	6.72	5.60	5.97
Ocl	6.14	5.36	4.13	6.55	5.17	4.96
$\frac{100}{B}$	5.67	3.57	4.47	6.36	3.34	4.68
L	5.51	6.15	6.34	6.17	5.46	5.72
$\frac{100}{O_2}$	5.32	5.67	5.77	5.58	5.50	5.68
O_2R	5.13	3.78	3.93	5.04	3.48	4.34
P \angle	5.01	4.14	4.51	5.03	3.88	4.70
$\frac{100}{B}$	4.96	4.67	3.40	4.87	4.62	4.75
H'	4.86	5.10	5.09	4.80	4.49	4.98
A \angle	4.80	4.90	5.45	4.74	4.75	5.18
GL	4.79	5.18	4.70	4.70	5.06	5.22
GB	4.60	4.28	4.84	4.40	4.11	4.54
N \angle	4.24	4.06	3.70	4.14	3.92	4.23
B'	4.05	4.06	4.65	3.99	3.90	4.63
$\frac{100}{H'}$	3.97	3.43	3.65	3.78	3.34	3.88
L	3.95	3.55	3.81	3.64	3.62	3.87
B	3.87	3.09	3.46	3.52	2.66	3.47
J	3.69	3.90	3.56	3.36	3.65	3.56
L	3.65	3.36	4.11	3.27	2.92	3.69
LB	3.13	3.22	3.27	3.01	2.98	3.20
S	3.07	3.75	3.72	2.94	3.39	3.68
BQ'	2.98	2.65	2.95	2.33	2.35	2.50
H'	2.91	2.16
U
GLU

foramen magnum, the upper facial height, and the B angle, no matter which racial group we inspect.

The study so far indicates that coefficients of variation are of very similar size, range, and grouping for the three races. But the table makes a racial distinction equally clear; there is a weighted divisional distribution of the higher coefficients in favor of males within each racial group.

The Egyptian series shows that males have the higher coefficients in the proportion of 29:2. That is to say, out of 31 pairs of coefficients (male and female) for the Egyptian series, the coefficient for males is larger than the corresponding coefficient for females for 29 out of the 31 traits. The skull traits of males are therefore decidedly more variable than those of females. The same tendency, though to a lesser degree, is observable in the New Guinea series, where coefficients for males are higher than those for females in the ratio 21:15. For Old English skulls the sex division of coefficients according to their magnitude gives a ratio of 19:16.

The conclusion is that, despite great similarities in the actual sizes and ranges of coefficients of variation, there is a distinct tendency within every racial group for males to have the larger coefficients, so indicating a greater variability in the male skulls. But we must be careful to note that our judgment of the extent to which male traits are more variable than female will depend considerably on the particular racial sample that we choose for demonstration.

The chief racial discrepancies in variability of skull characters pertain to the P angle, 100 B/L, 100 B/H', and OcI. The coefficients of variation for these traits in the New Guinea series are greater than the coefficients for corresponding traits in the Old English and the Egyptian series. The New Guinea skulls are therefore the most variable of our racial samples in respect to prognathism and three important indices just mentioned.

Apart from these exceptions, the general conclusions are that coefficients of variation show a marked racial uniformity in their size and range, but that males of each racial group, when compared with females of the same group, have the higher variability for a greater number of traits.

The similarity in magnitude of cranial coefficients for the races considered in this chapter agrees well with the research of Morant (1935), who attempts to establish the relative variabilities of various populations. He considers corporal measurements of certain European and Asiatic groups that are impressively different in physique, and his measure of variability is the standard deviations for numerous traits. He considers the samples both intra-racially and inter-racially, and states that the groups of people in different parts of the world exhibit average variabilities that are remarkably similar to one another.

From consideration of sex differences in Melanesian skulls the inquiry should now be extended to examine differences in measurements between Melanesian skulls of New Guinea, New Britain, and Ambrym. The skull series from New Britain (von Bonin, 1936) and from New Guinea (Hambly, 1940) provide the largest biometrical background yet published for making a comparative study with our small sample from Ambrym.

IV. MELANESIAN CRANIAL TYPES

CONTOUR DRAWINGS

Comparison of the average measurements of male skulls from New Guinea, New Britain, and Ambrym by means of contours (drawings, facing pp. 38, 46, 54) shows close resemblances in outline in all three sections. The sizes vary only slightly and the general visual impression is one of resemblances rather than differences.

Type contours are geometrical constructions based on the averages of measurements for the traits of each skull series, and the drawings are not sufficiently dependable to supply precise measurements or to show small differences with accuracy.

Dr. von Bonin (1936, p. 126) prepared a table in which he showed the difference between actual measurements on skulls, male and female, and corresponding measurements taken from life-size contours. Dr. Tildesley (1921b, p. 211) has made a similar study of contours of Burmese skulls. The results indicate clearly that although average contours give a fairly close approximation for some dimensions of the skull they should never be regarded as a reliable source for measuring traits in order to save the time required for making measurements on the skulls. Therefore, for detailed comparisons of the dimensions of the three types of Melanesian skulls represented here by contours reference should be made to the table (pp. 44, 45).

Photographs for comparison of general morphological differences, particularly those which are non-metrical, are given at the end of this work for Ambrym, for New Guinea by me (1940) and for New Britain by von Bonin (1936).

STATISTICAL COMPARISON OF AVERAGE MEASUREMENTS

For this purpose the reader will need to refer constantly to the table (pp. 44, 45) showing average measurements and their probable errors for male skulls from Ambrym (this work), New Guinea (Hambly, 1940) and New Britain (von Bonin, 1936). The preliminary work, which must be done before an assessment of differences and resemblances can be made, consists of a comparison of

traits taken a pair at a time for (1) Ambrym and New Guinea, (2) Ambrym and New Britain, (3) New Guinea and New Britain.

By mere inspection of the averages some of the close resemblances and the more distinct differences can be appreciated, and as the eye ranges over the collection of skulls there is an impression of uniformity of type relieved by peculiarities characteristic of each region. But general observation of contour drawings, photographs, and average measurements, combined with careful inspection of the skulls themselves, still leaves the study vague and inconclusive. If, however, we employ the statistical method described and used in making a study of the sex differences in Melanesian skulls (pp. 33-35) our general visual impressions will have a reliable biometric foundation.

The following table (p. 46) gives an arrangement of traits according to their Δ/P_{Δ} values. The acceptance of Δ/P_{Δ} values of 3 and under as an indication that the difference in average measurements is "not significant," is a procedure commonly used. This method has been further extended to classify differences in averages as "very small," "medium," and "marked." To some extent this classification of differences is arbitrary but, nevertheless, the method gives an accurate general impression.

A student who is unfamiliar with this method of using Δ/P_{Δ} values will find it instructive to compare certain averages in the table (pp. 44, 45) and then to note the classification of their differences as "not significant," "very small," and so forth. For example, actual average breadths of the skulls are 130.9, 131.3, 132.4, for Ambrym, New Guinea, and New Britain, respectively, and when these are compared in relation to their probable errors (see formula, p. 33) the Δ/P_{Δ} values are found to be below 3, so allowing us to state that, so far as our samples are trustworthy, there is (statistically speaking) no significant difference in the average breadths of skulls from these three regions.

An extreme difference (8.2 mm.) is found for J, the bizygomatic breadth, which is 136.2 for Ambrym and 128.0 for New Guinea. Such a decided difference leads to a high Δ/P_{Δ} value and classification as a "marked" difference.

The results of classifying Δ/P_{Δ} values for pairs of traits are as follows:

- (1) The closest resemblance exists between skulls of Ambrym and New Britain although the islands are 1,280 miles apart. Out of 45 traits compared, 38 are so close that the average measurements show no significant difference. Only two

AVERAGE MEASUREMENTS AND THEIR PROBABLE ERRORS

(1) Ambrym; (2) New Guinea; (3) New Britain

Locality	Capacity in cc.	L	B	B'	H'	LB	S _i	S _i '	S ₂
1. . . .	1318.7	182.4	130.9	94.2	131.2	98.9	124.1	110.1	133.9
	±15.46	±1.05	±0.61	±0.51	±0.73	±0.74	±0.80	±0.63	±1.43
2. . . .	1280.0	177.6	131.3	95.2	131.6	98.5	123.5	108.5	128.6
	±6.06	±0.41	±0.31	±0.26	±0.26	±0.24	±0.38	±0.26	±0.48
3. . . .	1285.7	184.3	132.4	93.3	134.7	100.9	124.5*	109.7*	132.5*
	±10.32	±0.25	±0.19	±0.22	±0.20	±0.18	±0.27	±0.19	±0.35
	S ₂ '	S ₃	S ₃ '	S	GLU	U	BQ'	GB	J
1. . . .	117.8	113.9	94.0	372.5	516.6	504.0	297.5	98.1	136.2
	±1.19	±0.97	±0.53	±2.12	±2.36	±2.84	±1.46	±0.47	±0.53
2. . . .	113.7	111.2	93.5	362.7	507.9	493.5	294.2	95.9	128.0
	±0.38	±0.49	±0.32	±0.86	±0.90	±0.89	±0.86	±0.28	±0.31
3. . . .	117.4*	117.5*	96.1*	374.6	518.7*	507.8	304.1*	97.0*	135.3
	±0.28	±0.33	±0.22	±0.53	±1.25	±0.61	±0.55	±0.19	±0.24
	G'H	GL	NHR	NHL	NH'	NB	O ₁ R	O ₂ R	O ₁ L
1. . . .	68.9	105.3	50.0	50.7	50.3	27.4	43.3	33.7	42.9
	±0.49	±0.58	±0.48	±0.40	±0.43	±0.27	±0.26	±0.30	±0.43
2. . . .	66.5	101.6	50.1	50.4	49.1	25.3	40.6	33.8	40.6
	±0.27	±0.32	±0.21	±0.19	±0.17	±0.10	±0.10	±0.11	±0.10
3. . . .	67.8	105.7	51.0*	51.0	47.5	26.8	43.9	33.1	44.4*
	±0.20	±0.15	±0.30	±0.30	±0.18	±0.08	±0.10	±0.08	±0.14
	O ₂ L	O ₁ R	O ₁ L	Lac O ₁ R	Lac O ₁ L	DC	G ₁	G ₂	G ₁ '
1. . . .	33.5	41.3	41.0	39.7	40.0	22.6	57.6	43.1	53.1
	±0.36	±0.18	±0.20	±0.25	±0.18	±0.33	±0.51	±0.47	±0.43
2. . . .	33.8	39.5	39.1	38.5	38.3	22.7	53.3	40.1	47.3
	±0.09	±0.13	±0.15	±0.14	±0.15	±0.12	±0.28	±0.21	±0.24
3. . . .	32.7*	40.6*	41.3	40.2*	40.0*	56.1	41.2	50.9
	±0.11	±0.08	±0.16	±0.16	±0.16	±0.20	±0.13	±0.13

traits, depth of palate and palatal index, show a "marked" difference. When measuring palatal depths of skulls, von Bonin used K. Pearson's instrument; I made the measurements on Ambrym skulls with P. Hermann's instrument (see my experiment with and discussion of the precision of these palatometers; 1940, pp. 96-97). Just this one measurement (E), the palatal depth, is open to question. The remarkable similarity, almost identity, of the Ambrym and New Britain series is established, and the series are both of a heavy-browed Australoid type.

- (2) Next in order of similarity are the Ambrym and New Guinea skulls, with 22 out of 45 traits having averages that show no significant difference. The bizygomatic width, the breadth of the nose, the length of the eye socket, and the palatal length are the "marked" differences, with Δ/P_{Δ} values above 6.

AVERAGE MEASUREMENTS AND THEIR PROBABLE ERRORS—Continued

(1) Ambrym; (2) New Guinea; (3) New Britain

Locality	EH	fml	fmb	$\frac{100B}{L}$	$\frac{100H'}{L}$	$\frac{100B}{H'}$	$\frac{100(B-H')}{L}$	Ocl
1	14.5	34.5	28.7	71.8	72.1	99.4	-0.10	59.9
	±0.42	±0.34	±0.38	±0.45	±0.36	±0.75	±0.22	±0.57
2	12.7	33.5	28.3	74.0	74.3	99.6	0.0	61.6
	±0.15	±0.15	±0.14	±0.26	±0.19	±0.32	±0.25
3	11.3*	34.3	28.3	71.9	73.2*	98.5*	-1.6	59.1
	±0.15	±0.10	±0.10	±0.12	±0.13	±0.22	±0.16	±0.15
	$\frac{100G'H}{GB}$	$\frac{100NB}{NHR}$	$\frac{100NB}{NH'}$	$\frac{100O_2R}{O_1R}$	$\frac{100O_2R}{O_1'R}$	$\frac{100O_2R}{LacO_1R}$	$\frac{100G_2}{G_1}$	$\frac{100G_2}{G_1'}$
1	70.0	55.0	54.7	78.0	81.8	84.8	75.2	81.3
	±0.49	±0.65	±0.70	±0.86	±0.89	±0.97	±0.95	±0.95
2	69.1	50.7	51.7	83.6	86.3	88.5	75.2	84.0
	±0.30	±0.25	±0.27	±0.28	±0.49	±0.53	±0.51	±0.54
3	70.0*	53.8*	56.4	75.4	81.3*	81.0*	73.3	82.1*
	±0.23	±0.36	±0.23	±0.30	±0.31	±0.59	±0.48	±0.77
	$\frac{100EH}{G_2}$	$\frac{100fmb}{fml}$	A ∠	B ∠	N ∠	P ∠	Pros. P∠	Weight in gms.
1	33.5	83.4	65.9	39.1	75.0	79.7	77.8	610.7
	±0.84	±1.09	±0.44	±0.30	±0.48	±0.64	±0.61	±15.5
2	31.4	84.6	68.1	38.7	73.1	82.8	80.4
	±0.34	±0.38	±0.22	±0.16	±0.23	±0.27	±0.26
3	27.1*	82.6	67.1	38.2	74.7	78.4*	76.8	622.1
	±0.49	±0.26	±0.16	±0.12	±0.18	±0.38	±0.32	±6.90

The standard deviations have been worked out for the Ambrym and New Guinea series. For New Britain von Bonin (1936, p. 131) gives standard deviations which he calculated. For the items marked with an asterisk in the New Britain series the standard deviations of the New Guinea series were used because von Bonin does not include these standard deviations in his table.

- (3) The greatest differentiation of series occurs in comparison of skulls from New Guinea and New Britain, although the islands are geographically close. Only 9 pairs of traits out of 44 pairs considered may be said to show "no significant difference," while 11 traits have "small" or "medium" differences. One must bear in mind, however, that our system of classification according to Δ/P_{Δ} values is an arbitrary one; a small change in these values can transfer traits from one category to another. Several traits are for this reason classed as "marked" differences, though they are very close to "medium" differences.

Despite any disadvantages there may be in this approximate method, the foregoing general truths are clear, and we may reasonably go a step farther to inquire in detail into the nature of the resemblances which appear in our table as "not significant," "very small," and "medium." On this occasion, however, our attention

CLASSIFICATION OF Δ/P_{Δ} VALUES: AMBRYM, NEW GUINEA, NEW BRITAIN

	Differences Not Significant Δ/P_{Δ} less than 3	Very Small Differences Δ/P_{Δ} 3-4	Medium Differences Δ/P_{Δ} 4-6	Marked Differences Δ/P_{Δ} 6+
Ambrym and New Guinea: 45 traits, average Δ/P_{Δ} value 3.47	100 fmb/fml, B angle, C, B, B', H', LB, S ₁ , S ₁ ', S ₃ , S ₃ ', BQ', NHR, O ₂ R, DC, fml, fmb, 100 B/H', Ocl, 100 G'H/GB, 100 G ₂ /G ₁ ', 100 EH/G ₂	S ₂ ', S ₂ , S, GLU, U, N angle, Pros. P angle	L, GB, G'H, GL, G ₂ , EH, 100 B/L, 100 H'/L, 100 NB/NHR, A angle, P angle	J, NB, O ₁ R, G ₁ ', 100 O ₂ /O ₁ (R)
Totals	22	7	11	5
Ambrym and New Britain: 45 traits, average Δ/P_{Δ} value 1.99	C, L, B, B', LB, S ₁ , S ₁ ', S ₂ , S ₂ ', S ₃ ', S, GLU, U, GB, J, G'H, GL, NHR, NB, O ₁ R, O ₂ R, fml, fmb, 100 B/L, 100 H'/L, 100 B/H', Ocl, 100 G'H/GB, 100 NB/NHR, 100 O ₂ /O ₁ (R), 100 G ₂ /G ₁ ', 100 fmb/fml, A, B, N, P, Pros. P angles, weight	S ₃ ', G ₂	H', BQ', G ₁ '	EH, 100 EH/G ₂
Totals	38	2	3	2
New Guinea and New Britain: 44 traits, average Δ/P_{Δ} value 5.94	C, B, S ₁ , NHR, fmb, 100 B/H', 100 G'H/GB, 100 G ₂ /G ₁ ', B angle	GB, A angle, G'H	B', S ₁ ', O ₂ R, G ₂ , fmb, 100 H'/L, 100 fmb/fml, N angle	L, H', LB, S ₂ , S ₃ , S ₃ ', S ₂ ', S, GLU, U, BQ', J, GL, NB, O ₁ R, G ₁ ', EH, 100 B/L, Ocl, 100 NB/NHR, 100 O ₂ /O ₁ (R), 100 EH/G ₂ , P and Pros. P angles
Totals	9	3	8	24
A total of 134 comparisons shows:	69 comparisons with no significant differences	12 comparisons with very small differences	22 comparisons with medium differences	31 comparisons with marked differences

The small number of "marked" differences (31:134=23%) is a clear indication of the close relationship between these three series of Melanesian crania. This is further attested by 69 comparisons that show no significant differences.

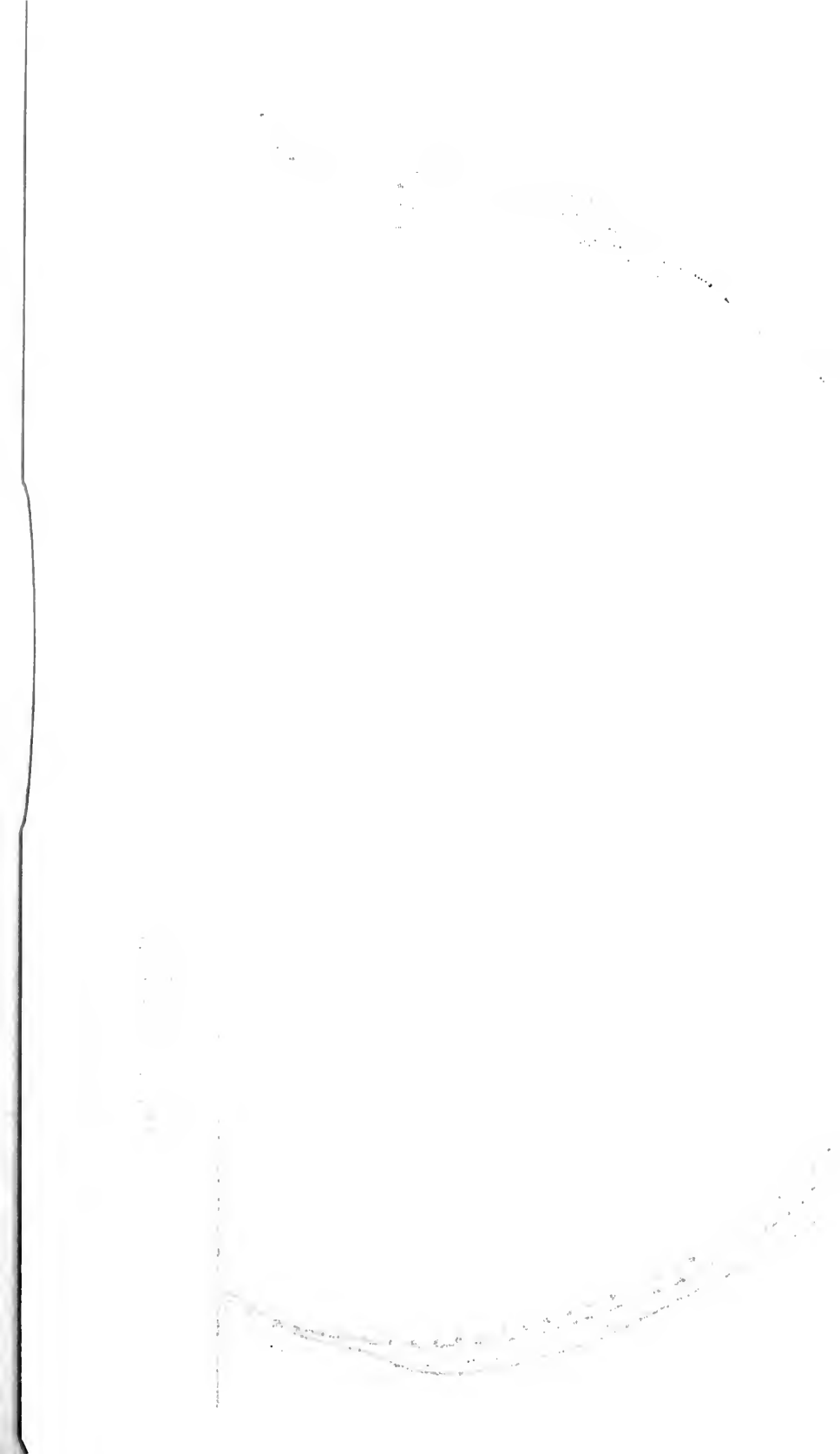

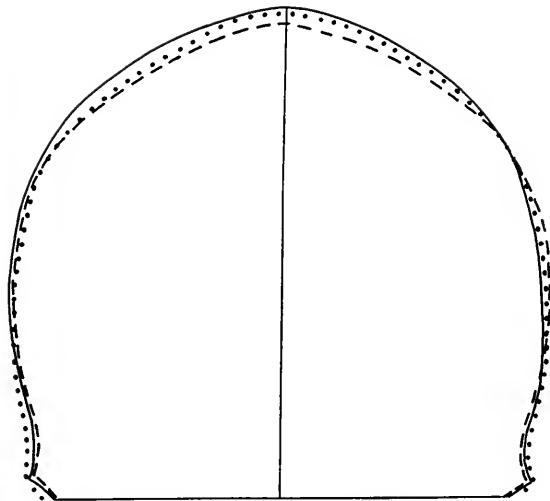

AVERAGE VERTICAL CONTOURS (MALES)

Ambrym, 19 (solid line); New Guinea, 124 (broken line); New Britain, 62 (dotted line)

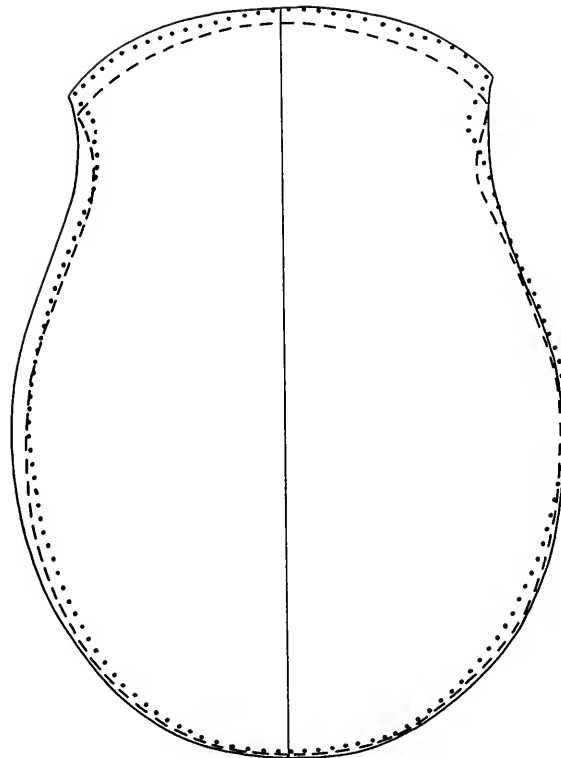

AVERAGE HORIZONTAL CONTOURS (MALES)

Ambrym, 19 (solid line); New Guinea, 124 (broken line); New Britain, 62 (dotted line)

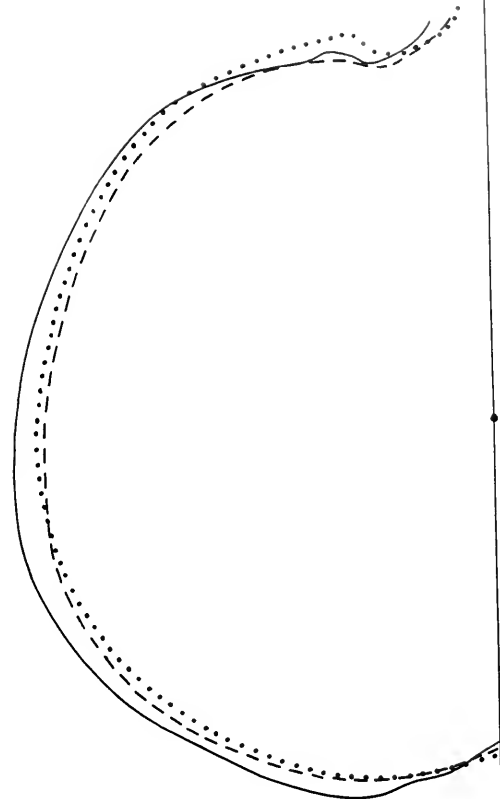

AVERAGE SAGITTAL CONTOURS (MALES)
 Ambrym, 19 (solid line); New Guinea, 124 (broken line); New Britain, 62 (dotted line)

will be given, not to Ambrym, New Guinea, and New Britain taken a pair at a time, but to the three regions considered together. What are the traits that convey the impression of a Melanesian type that persists through the three series, despite their differences?

The summary given below tabulates the traits which, when judged by average values in relation to their probable errors, show either "not significant," "very small," or "medium" differences. Most differences that can be classed in this way are such as the eye would not differentiate; they are small in actual millimeters. Even some of the differences that we have agreed to call "marked" are deserving of the name in a statistical sense only; the eye might not notice them.

Traits Most Alike in Three Melanesian Skull Groups:

SKULL FORM: C, B, 100 B/H', 100 H'/L, S₁', S₁, B'.

FACE: G'H, GB, 100 G'H/GB, O₂R, NHR.

BASE: fml, fmb, 100 fmb/fml, G₂, 100 G₂/G₁'.

ANGLES: A, B, N.

A total of 20 traits are so alike for Ambrym, New Guinea, and New Britain that they have to be classed as "not significant," "very small," or "medium" differences. The eye will not detect differences in cranial capacity, maximum breadth, the relationship of breadth to height, of height to length, of the frontal chord and the arc between nasion and bregma, and of the minimum width of the forehead.

In these fundamental resemblances in size and proportion there is enough likeness to establish a visual impression of Melanesian similarity among the three series. Again, in the face alone we have to note that the upper facial height, the greatest breadth, the facial index, the height of the orbit, and the height of the nose are traits with no "marked" differences. The table (p. 46) shows the likely categories of these traits, whether "very small," "medium," or "not significant." The respective averages indicate that if we inspect the bases of skulls from the three series, no differences will be observable in the foramen magnum, the breadth of the palate, or the proportion of palatal breadth to length.

Most important of all is the close resemblance of the A, B, and N angles of the facial triangles of all three series. When studying sex differences in Melanesian skulls (p. 33) we noted that, although male skulls were significantly larger than female skulls in nearly all traits, the Melanesian type of physiognomy was preserved by the

constancy of the three facial angles. Now once more the measurements show that retention of constant, or nearly constant, facial angles A, B, N helps to preserve a characteristic Melanesian physiognomy in the series from Ambrym, New Guinea, and New Britain.

Basing my conjecture on inspection of skulls from these three regions I surmise that the New Guinea series bears a close resemblance to both Negroid and Australoid series, but more particularly to the former. On the other hand, the skulls of Ambrym and New Britain are predominantly Australoid, if one may judge by general appearance. The morphological characters of the Australian skull have been summarized by Krogman (1932), Wood-Jones (1929), Burkitt and Hunter (1922-23), and Burkitt and Lightoller (1922-23). The description of Burkitt and Hunter relates, however, to an exceptionally heavy type of Australian skull, one with an unusually large glabella and strongly developed torus occipitalis. This Neanderthal type has a very receding forehead, great massiveness, and noticeable thickness of the cranial vault.

Krogman's description of Australian skulls in the Royal College of Surgeons, England, emphasizes massiveness of the brow ridges; great size and rectangular shape of the eye orbits, which have a cavernous appearance; great size of the palatal arch and teeth; narrowness of the frontal part of the cranial vault; and marked subnasal prognathism. All these notes would apply aptly to our sample of skulls from Ambrym.

These visual impressions of likeness between the skulls of Ambrym, New Guinea, and New Britain, and those of Australia and Negro East Africa, should now be tested by a detailed statistical comparison of the traits.

V. AUSTRALIAN, NEGRO, AND POLYNESIAN TRAITS IN AMBRYM SKULLS

METHOD OF COMPARING AVERAGE MEASUREMENTS

In a previous publication (Hambly, 1940, pp. 266-269) I made a detailed comparison, trait by trait, between series of skull measurements from New Guinea and other regions of Oceania. The same traits were used for each comparison, and the method was based on use of the expression

$$M_1 - M_2 / \sqrt{(PE_1)^2 + (PE_2)^2}$$

which gives Δ/P_{Δ} values. A Δ/P_{Δ} value of 3 or less was accepted as an indication that no significant difference could be assumed between the two averages.

As a "control," the Melanesian series, which show many similarities, were compared with a group of Old English skulls. This was done to ascertain how many close resemblances could be found between average measurements of series of crania that are obviously of very different types. Let us explain this idea in more detail.

Presumably, human skulls have had a phylogenetic history that might lead to some identities in average measurements, simply because they are human skulls whose correlations and dimensions for the various traits must lie within certain limits (Fawcett and Lee, 1902; Pearson and Davin, 1924). In other words, before we proceed to speak of the close resemblance of skull series we need to have in mind a datum of unlikeness, and an estimate of chance resemblances.

THE NATURE OF LIKENESS AND UNLIKENESS

The following examples illustrate the degrees of resemblance that have been obtained by comparison of pairs of traits according to the method described above.

Comparison of a New Guinea and an Old London series of skulls revealed only two traits (O_2 and G_2) whose average measurements showed no significant difference. The same degree of resemblance, namely 2:27 was found for a New Britain-Old London comparison. These ratios represent the lowest degree of resemblance I have found

between any two series of skulls. A comparison of Australian and Old London skulls gave a 4:27 trait resemblance.

On the other hand the closest likeness such a method has yet revealed is the one quoted in this work (p. 46), where comparison of 45 traits for skulls of two Melanesian groups, Ambrym and New Britain, indicated that 38 of the traits had average measurements with no significant difference.

A series of Australian skulls showed an unsuspectedly high ratio of likeness with a Negro series from the WaTeita tribe of East Africa. The trait ratio was 19:27. My conclusion is, that in judging the living Australian type to be so very different from the Negro type, one is deceived by great disparities, for example, quantity and texture of hair, body form, and skin color. Again, the heavy brow ridges of the Australian and the comparatively smooth supraciliary region of the Negro skull are impressively different. I feel sure we are all apt to assess the differences between two series, whether skulls or living people, by a few "marked" differences, while ignoring many close resemblances.

The visual impression that skulls from New Guinea are of strongly Negroid appearance is borne out by biometric comparison. Apparently there are 12 out of 27 Negro-New Guinea traits whose average measurements, considered a pair at a time, show no significant differences.

With these general conceptions of likeness and unlikeness in mind we may pass to a detailed consideration of the racial likenesses of Ambrym skulls; and since the Ambrym sample is small, a trait by trait comparison, though making no claim to perfection, will perhaps be preferable to use of the coefficient of racial likeness.

AMBRYM SKULLS: THEIR RACIAL RESEMBLANCES AND DIFFERENCES OUTSIDE MELANESIA

Pictorial Evidence

The contours (drawings, facing pp. 38, 46, 54) indicate a close correspondence in the horizontal section of Ambrym, Australian, Maori, and Negro skulls. The vertical contours stress the greater width of the Maori skulls. The sagittal contour shows close correspondence at the frontal bone, yet a marked prominence of the Australian and Maori glabella. But the table of average measurements and their probable errors (pp. 44, 45) is the only reliable source for study of details.

Photographic studies for Ambrym skulls are given in this work (plates 1-30), and these should be compared with photographs for Negro skulls given by Kitson (1931), Australian skulls (Fenner, 1939), and Moriori skulls (E. Y. Thomson, 1915-17) for a Polynesian type.

The foregoing visual impressions are useful, especially when aided by detailed morphological descriptions such as those given by Fenner for Australian skull types, but at the end of all the glancing back and forth from one series of photographs and outline drawings to another, noticing differences and resemblances, one is left with a desire to base the judgments on some concrete statistical evidence, and here our difficulties begin.

Available Data and Their Defects

We have the average measurements for only 19 male skulls from Ambrym, and so far as I know there exists no published account of measurements on skulls from this island of the New Hebrides. We have therefore to accept this small sample as a basis for comparative study or to do nothing at all.

One may take some consolation from the fact that the standard deviations for the 19 Ambrym males indicate great uniformity, and they are in close agreement with series of standard deviations for much larger collections of Melanesian skulls, notably the 124 males from New Guinea (Hambly, 1940).

For Ambrym skulls my table of measurements (pp. 44, 45) records 60 averages of linear measurements, curves, capacity, weight, angles, and indices, but on consulting the literature a difficulty is encountered in finding large series on which the observer has made so many measurements. After careful consideration of the techniques used and the pooling of figures one feels that the best samples for comparison are:

- (1) Dr. von Bonin's unpublished average measurements for pooled Polynesians, which he kindly gave permission to use. The Easter Islanders are excluded because they present a somewhat aberrant type, at any rate in several important traits. The pooling gave 172 male skulls, and an average of 114.9 skull measurements for each trait. A few traits are not mentioned in von Bonin's series, but these are given by Wagner (1937) for 40 Maori males. They are S_1 to S_8 , both included (cranial arcs and chords), and measurements on eye sockets. A good impression of the physical types of living

Polynesians whose craniometric data are pooled will be given by consulting numerous articles prepared by Sullivan, and by Shapiro (see bibliography).

- (2) The data of Kitson (1931) for 55 males of the WaTeita tribe of East Africa. The average number of measurements per trait is 37.9.
- (3) The pooled figures for 103 crania of male Australian aborigines given by Wagner (1937). The average number of measurements is 99.2 per trait. Pooling of figures for Australians is a process open to objection because of regional differences. Wagner quotes the average measurements for six regional groups, but selection of any one of these divisions gives us only a very small Australian sample. Howells (1937a) has described differences in physique among living Australians, and anthropometric surveys showing regional differences in living subjects are to be found in the contributions of Campbell and Hackett (1928), Campbell and Lewis (1926), Wood-Jones and Campbell (1924), and Burston (1913).

In summarizing the non-metrical morphological distinctions of 1,182 Australian skulls, Fenner (1939) makes three divisions, two of which are from the Northern Territory and Queensland areas, and a third which he calls "the common southern type," which occurs over the greater part of Australia.

Fenner's description of the "southern" or general type fits very well with our measured characters given in the table (pp. 54, 55). The typical Australian skull is long, low, and narrow with a receding forehead, but the commonly accepted idea of "tremendous brow ridges" and a "brutish appearance" must be modified. Ideas of "cavernous orbits, a very large palate, and a strongly keeled cranial vault" are erroneous. Such conceptions have arisen from descriptions of "outlandish male skulls, with exaggerated racial and sexual characters." Fenner gives a large bibliography relating to craniometry of Australian aborigines. To supplement biometric studies such as those made in this chapter, and to give to measurements (Morant, 1927; Hrdlička, 1928) a morphological background, the contributions of Wood-Jones (1931a, b) and Krogman (1932) are very useful. Students who are interested in blood-group studies will find many references thereto in Fenner's bibliography, also in an article by Birdsell and Boyd (1940).

According to Campbell, Gray and Hackett (1936), considerations of blood grouping alone or in conjunction with anthropometric data

do not indicate the existence of distinct physical types among Central Australian tribes. But Birdsell and Boyd (1940, p. 85) state that three distinct ethnic elements seem to have entered Australia over a period sufficiently long to allow them to permeate the continent and to mingle. The views of Birdsell have been more recently expressed in his thesis relating to the trihybrid origin of the Australian aborigines. Copies of the thesis are deposited in the Widener and Peabody Museum Libraries, Harvard University (1941).

Heine-Geldern's article (1921) asking "Gibt es eine austro-asiatische Rasse?" is largely a review of cultural and linguistic data from Asia and Australia. Students who wish to make a thorough study in which all kinds of evidence are given their due weight should include in their reading a contribution entitled *The Nature of Australian Languages* (Elkin, 1937). Davidson's (1938) ethnic map of Australia will be useful in all Australian studies.

So far as purely cranial and biometric problems are concerned, several main sources are Morant (1927), Wagner (1937), and Hrdlička (1928). Discussion of statistical objections to pooling is given by Morant, again by Wagner. All evidence considered, I believe a large pooled Australian group will serve our purpose better than the use of average measurements relating to a much smaller and geographically restricted Australian group.

Wagner supplies standard deviations for the Australian group with a few exceptions (S_2' , S_3' , GLU, GB, 100 G'H/GB, and the P angle) for which I have used the standard deviations for my 124 New Guinea males. I have also used this series of standard deviations for measurements S_1 to S_3' (both included), GLU, GB, 100 B/H', 100 G'H/GB and the P angle, for which standard deviations are not given by Kitson for the East African Negro series.

Preliminary Inspection of Average Measurements

Before making a detailed statistical comparison of the Ambrym skulls, trait by trait, with those of Australia, East Africa, and Polynesia let us glance at the table (pp. 54, 55) to gain a general idea of the resemblances and the differences. We can then proceed to test these impressions more precisely.

Evidently the cranial capacities for skulls of Ambrym, Australia, and East African Negroes are within a few cubic centimeters of one another, and their breadths are so close that the differences are almost certainly "not significant."

COMPARISON OF AMBRYM SKULLS WITH THOSE OF OTHER REGIONS OUTSIDE MELANESIA

Region	Capacity in cc.	L	B	B'	H'	LB	Si	Si'	Si ₂	Si ₂ '
Ambrym	1318.7 ±15.46	182.4 ±1.05	130.9 ±0.61	94.2 ±0.51	131.2 ±0.73	98.9 ±0.74	124.1 ±0.80	110.1 ±0.63	133.9 ±1.43	117.8 ±1.19
Australia	1294.6 ±6.93	186.6 ±0.39	130.8 ±0.32	95.7 ±0.33	133.8 ±0.33	102.5 ±0.28	129.4 ±0.52	113.3 ±1.25	129.7 ±0.58	116.6 ±1.33
East African Negroes	1316.1 ±20.72	183.9 ±0.56	129.6 ±0.40	96.1 ±0.41	130.8 ±0.45	101.5 ±0.44	126.9 ±0.58	110.2 ±0.40	126.6 ±0.73	113.9 ±0.57
Pooled Polynesians	1470.3 ±5.19	186.0 ±0.32	138.6 ±0.24	94.5 ±0.34	138.2 ±0.28	104.5 ±0.21	130.5 ±1.21	114.8 ±0.80	125.4 ±1.08	113.3 ±0.91

Region	S ₁	S ₁ '	S	GLU	U	BQ'	GB	J	G'H	GL
Ambrym	113.9 ±0.97	94.0 ±0.53	372.5 ±2.12	516.6 ±2.36	504.0 ±2.84	297.5 ±1.46	98.1 ±0.47	136.2 ±0.53	68.9 ±0.49	105.3 ±0.58
Australia	114.3 ±0.49	97.4 ±1.00	371.5 ±0.86	530.2 ±2.18	511.7 ±0.99	299.9 ±0.67	93.9 ±0.51	135.1 ±0.39	68.9 ±0.27	102.0 ±0.38
East African Negroes	113.5 ±0.74	93.5 ±0.50	366.6 ±1.40	511.0 ±1.41	506.6 ±1.24	298.6 ±0.81	98.1 ±0.50	130.9 ±0.59	68.5 ±0.49	100.2 ±0.59
Pooled Polynesians	120.9 ±1.06	100.2 ±0.71	377.7 ±0.70	523.7 ±1.17	516.3 ±0.74	314.9 ±0.79	99.1 ±0.69	135.8 ±0.27	70.0 ±0.25	100.5 ±0.30

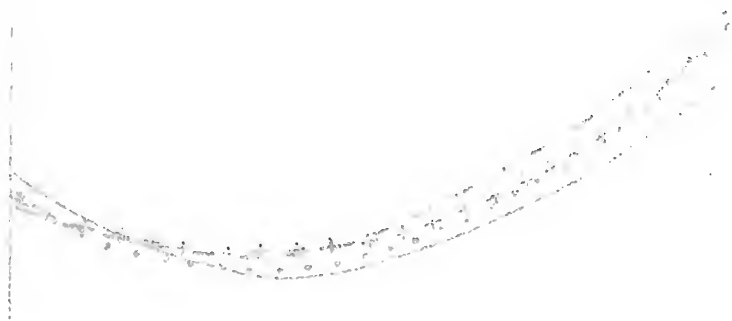

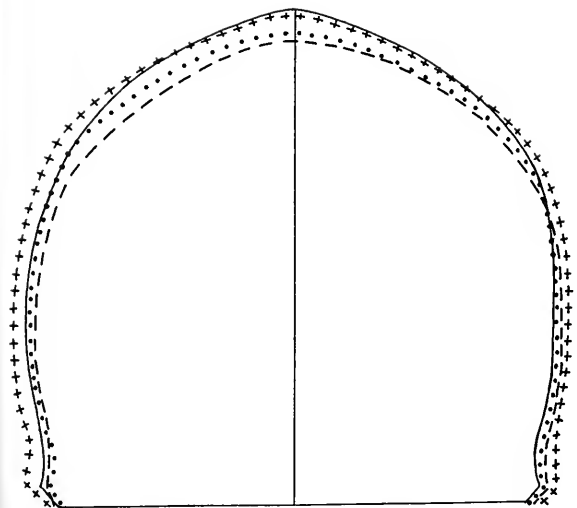

AVERAGE VERTICAL CONTOURS (MALES)
 Ambrym, 19 (solid line); Australian, 82 (broken line); Maori, 38 (crosses);
 Negro, 46 (dotted line)

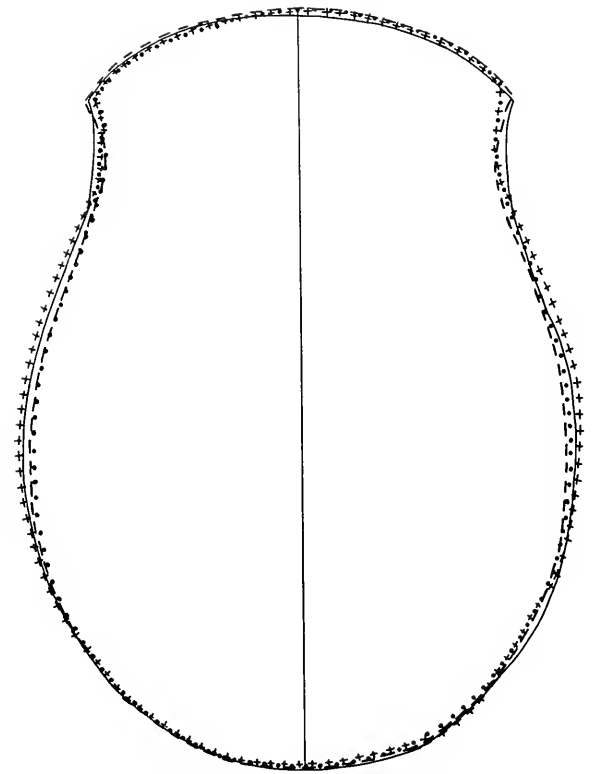

AVERAGE HORIZONTAL CONTOURS (MALES)
 Ambrym, 19 (solid line); Australian, 82 (broken line); Maori, 38 (crosses); Negro, 46 (dotted line)

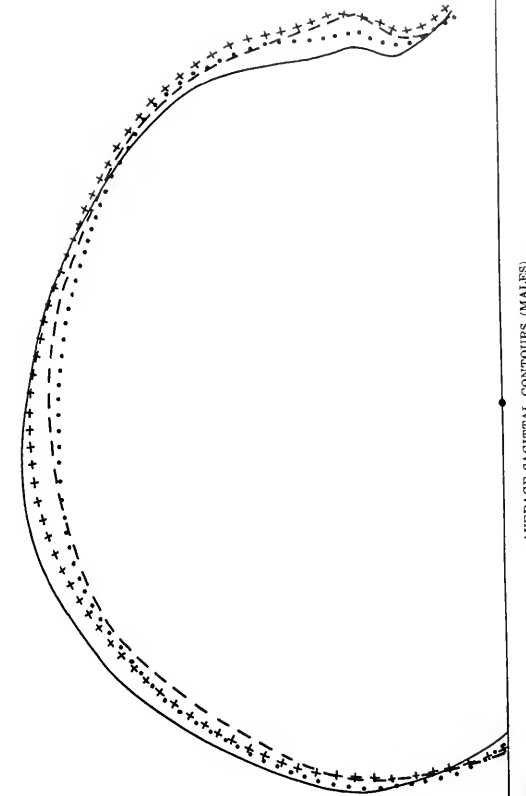

AVERAGE SAGITTAL CONTOURS (MALES)
 Ambrym, 19 (solid line); Australian, 82 (broken line); Maori, 38 (crosses); Negro, 46 (dotted line)

COMPARISON OF AMBRYM SKULLS WITH THOSE OF OTHER REGIONS OUTSIDE MELANESIA—Continued

Region	NHL	NB	O ₁ R	O ₂ R	G ₂	G ₁ '	fml	fmb	Ocl	$\frac{100G'H}{GB}$	$\frac{100B}{L}$
Ambrym	50.7 ±0.40	27.4 ±0.27	43.3 ±0.26	33.7 ±0.30	43.1 ±0.47	53.1 ±0.43	34.5 ±0.34	28.7 ±0.38	59.9 ±0.57	70.0 ±0.49	71.8 ±0.45
Australia	51.2 ±0.23	27.2 ±0.13	44.2 ±0.13	33.7 ±0.15	40.4 ±0.17	51.9 ±0.23	36.3 ±0.15	30.7 ±0.13	60.1 ±0.18	73.4 ±0.44	70.1 ±0.18
East African Negroes	49.6 ±0.29	27.6 ±0.17	43.6 ±0.17	33.9 ±0.19	39.3 ±0.36	46.9 ±0.38	36.5 ±0.26	29.5 ±0.17	59.5 ±0.21	69.4 ±0.66	70.6 ±0.28
Pooled Polynesians	53.5 ±0.22	25.7 ±0.09	43.6 ±0.15	35.8 ±0.10	40.7 ±0.21	48.8 ±0.26	34.8 ±0.15	30.2 ±0.13	60.3 ±0.26	71.9 ±0.38	74.7 ±0.15

Region	$\frac{100H'}{L}$	$\frac{100B}{H'}$	$\frac{100NB}{NH'}$	$\frac{100O_2R}{O_1R}$	$\frac{100G_2}{G_1'}$	$\frac{100fmb}{fml}$	A	B	N	P
Ambrym	72.1 ±0.36	99.4 ±0.75	54.7 ±0.70	78.0 ±0.86	75.2 ±0.95	83.4 ±1.09	65.9 ±0.44	39.1 ±0.30	75.0 ±0.48	79.7 ±0.64
Australia	71.8 ±0.22	99.3 ±0.29	54.0 ±0.33	76.2 ±0.35	77.9 ±0.38	84.6 ±0.36	70.5 ±0.27	39.1 ±0.17	70.4 ±0.28	84.2 ±0.76
East African Negroes	71.4 ±0.65	98.9 ±0.51	58.3 ±0.43	77.8 ±0.54	74.0 ±1.15	81.8 ±0.63	71.2 ±0.44	39.6 ±0.34	69.2 ±0.43	83.2 ±0.52
Pooled Polynesians	74.4 ±0.17	100.1 ±0.25	49.7 ±0.29	82.1 ±0.51	83.4 ±0.55	86.7 ±0.36	72.1 ±0.21	39.5 ±0.16	68.4 ±0.20	83.0 ±0.52

COMPARISON OF TRAITS: AMBRYM, AUSTRALIAN, NEGRO, POLYNESIAN

Regions Compared	Differences Not Significant Δ/P_{Δ} less than 3	Very Small Differences Δ/P_{Δ} 3-4	Medium Differences Δ/P_{Δ} 4-6	Marked Differences Δ/P_{Δ} 6+
Ambrym and Australian: 41 traits, average Δ/P_{Δ} value 2.73	C, B, B', S ₁ ', S ₂ , S ₂ ', S ₃ , S ₃ ', S, U, BQ', J, G'H, NHL, NB, O ₁ R, O ₂ R, G ₁ ', 100 H'/L, 100 B/H', OcI, 100 NB/NH', 100 O ₂ /O ₁ (R), 100 G ₂ /G ₁ ', 100 fmb/fml, B angle	L, H', 100 B/L	LB, S ₁ , GLU, GL, G ₂ , fml, fmb, 100 G'H/GB, P angle	GB, A angle, N angle
Totals	26	3	9	3
Ambrym and Negroes of East Africa: 41 traits, average Δ/P_{Δ} value 2.60	C, L, B, B', H', LB, S ₁ , S ₁ ', S ₂ ', S ₃ , S ₃ ', S, GLU, U, BQ', GB, G'H, NHL, NB, O ₁ R, O ₂ R, fmb, 100 B/L, 100 H'/L, 100 B/H', OcI, 100 G'H/GB, 100 O ₂ /O ₁ (R), 100 G ₂ /G ₁ ', 100 fmb/fml, B angle	None	S ₂ , fml, 100 NB/NH'	J, GL, G ₂ , G ₁ ', A angle, N angle, P angle
Totals	31		3	7

In length the Ambrym skull comes close to that of East Africa, but the Australian skull is definitely longer than either of them. For the three regions just mentioned the heights of the skull are remarkably close. Occipital indices are almost the same, implying uniformity of the occipital regions.

The breadth of the face (GB) is exactly the same (98.1) for Ambrym and East African Negroes, but the Australian face is definitely narrower. The height of the face (G'H) is a uniform measurement, 68.9, 68.9, 68.5, for the three racial samples.

The absolute breadths of the nose will probably show no significant difference, but the Negro nose is definitely broader in relation to its height. Eye sockets show differences probably negligible.

Length-breadth indices are 71.8, 70.1, and 70.6 for Ambrym, Australian, and Negro skulls, respectively; and the relationships 100 H'/L and 100 B/H' are just as close.

COMPARISON OF TRAITS: AMBRYM, AUSTRALIAN, NEGRO, POLYNESIAN—Continued

Regions Compared	Differences Not Significant Δ/P_{Δ} less than 3	Very Small Differences Δ/P_{Δ} 3-4	Medium Differences Δ/P_{Δ} 4-6	Marked Differences Δ/P_{Δ} 6+
Ambrym and Polynesians: 41 traits, average Δ/P_{Δ} value 4.7	B', S ₂ ', S, GLU, GB, J, 100 B/H', OcI, 100 G'H/GB, 100 fmb/fml, B angle, G'H, O ₁ R	L, P angle, O ₂ R, fmb	S ₁ , S ₁ ', S ₂ , S ₃ , U, 100 H'/L, 100 O ₂ /O ₁ (R), NHL, NB, G ₂	C, B, H', LB, S ₃ ', BQ', 100 B/L, 100 NB/NH', 100 G ₂ /G ₁ ', A angle, N angle, GL, G ₁ '
Totals	14	4	10	13
Ambrym, Australian, and Negro: 41 traits	C, B, BQ', 100 B/H', 100 H'/L, OcI, U, S, S ₁ ', S ₂ ', S ₃ ', S ₃ , O ₁ R, O ₂ R, 100 O ₂ /O ₁ (R), B', B angle, G'H, NB, NHL, 100 fmb/fml, 100 G ₂ /G ₁ '	None	100 B/L, 100 GH'/GB, fmb, L, H', S ₂ , LB, S ₁ , GLU, fml, 100 NB/NH'	A angle, N angle, P angle, GL, GB, J, G ₂ , G ₁ '
Totals	22		11	8
Ambrym, Australian, Negro, and Polynesian: 41 traits	B', S ₂ ', S, 100 B/H', OcI, 100 fmb/fml, B angle, G'H, O ₁ R	None	L, 100 H'/L, U, GLU, S ₁ , S ₁ ', S ₂ , S ₃ , 100 G'H/GB, O ₂ R, 100 O ₂ /O ₁ (R), NB, NHL, fml, fmb	B, C, H', 100 B/L, LB, BQ', S ₃ ', P angle, J, GB, G ₂ , G ₁ ', 100 G ₂ /G ₁ ', 100 NB/NH', A angle, N angle, GL
Totals	9		15	17

The skulls of the three regions have, in the facial triangle, almost identical B angles, but other angles show what will probably prove to be "marked" differences.

Now, if our eye shifts down to the average measurements for Polynesian skulls, the differences between these and those just compared is impressive. The Polynesian skull is substantially the largest, and though the length is equalled by that of the Australian skull, the Polynesian skull has a strikingly greater height and breadth. Because of correlation of measurements, we naturally find that S, the curve from nasion to opisthion, is larger than in the other skull groups; so also is BQ', the curve from porion to porion, over bregma. If we subtract the measurement U from GLU we

have a difference that gives a good idea of the size of glabella and the supraciliary ridges. The Australian skull has the largest frontal brow ridge, and Ambrym skulls are second in this respect. The frontal regions of the Negro and Polynesian skulls are relatively flat; the Negro forehead is noticeably the flattest of the four samples.

Polynesians have the narrowest noses, both absolutely and in relation to nasal height, of all four samples. The breadth-length and the height-length indices are noticeably highest for Polynesian skulls.

The following table tests the accuracy of these visual impressions by a statistical comparison of the averages and their probable errors, trait by trait, for Ambrym compared with each of the regions of Australia, East Africa, and Polynesia. The table also shows which traits may be regarded as common to three and even to the four regions considered.

PERCENTAGE LIKENESSES, AMBRYM AND SOME REGIONS
OUTSIDE MELANESIA

Prepared from the Table of Trait Analysis (p. 57)

	Differences not significant	Very small differences	Medium differences	Not signifi- cant, very small, and medium differences combined	Marked differences
Ambrym } Australian }	63.4	7.3	21.9	92.7	7.3
Ambrym } Negro }	75.6	0.0	7.3	82.9	17.1
Ambrym } Polynesian }	34.1	9.7	24.4	68.3	31.7
Ambrym } Australian Negro }	53.6	80.5	19.5
Ambrym } Australian Negro Polynesian }	21.9	58.5	41.5

The "percentage likeness" is the number of traits in any particular category multiplied by 100, and then divided by the total number of traits (41) used in comparing the two series.

The table showing comparison of traits (pp. 56, 57) and the table above, giving percentage likenesses, bring out the following points clearly. The number of traits used for comparison is always 41, and no variation is made in the choice of traits.

Summary of Statistical Comparisons

- (1) Ambrym skulls have a large number of Negro traits, since 31 average measurements show no significant differences

from the corresponding averages for Negro skulls. Only 7 "marked" differences exist, and important among these are the A angle, N angle, and P angle, which determine facial types. The bizygomatic breadth is much greater for the Ambrym skulls, and so is the distance from basion to nasion. The Ambrym palate is appreciably larger than the Negro palate.

- (2) Ambrym skulls have also a strong likeness to Australian skulls, and between the two there are 26 traits showing no significant difference. There are only 3 "marked" differences, namely, A and N angles of the facial triangle, and the width of the face between the lowest points of the malar sutures.
- (3) Our visual impression that the Ambrym skulls are more Australoid than Negroid prevails despite the biometric decision that Ambrym skulls have 31 Negro traits and only 26 Australoid traits. We must remember that our visual judgments are based, not only on close resemblances, but perhaps more accurately on the "marked" differences. We have just noted that these differences are 7 for the Ambrym-Negro comparison, and only 3 for the Ambrym-Australian comparison.
- (4) The Melanesian (Ambrym), Negro, and Australian relationship is seen in the fact that there are for the three groups 22 traits whose averages show no significant difference. If we pool the "not significant," "very small," and "medium" differences we have left only 8 "marked" differences; these give the Ambrym skulls their Melanesian character. We have to note again the angles of the facial triangle as distinctive features, also J, GB, GL, together with the palatal length and breadth.
- (5) Comparison of skulls of Ambrym with a pooled Polynesian sample gives 14 "not significant" differences. Among these are a few, namely, minimum frontal diameter, the B angle, and dimensions on the foramen magnum, all of which show a tendency toward entrenchment and low variability from one sample to another. Nevertheless, there are at least 10 "not significant" differences constituting a link between the Melanesian (Ambrym) and the Polynesian skulls.

Inspection of the skulls from Ambrym does not suggest Polynesian mixture though, theoretically at any rate, miscegenation might have occurred. Buck's (1938) map does not show Ambrym to have

been touched by Polynesian migrations; but the charts of Smith (1904) and Best (1918) mark a line of Polynesian migration from Samoa to Fiji, thence through the New Hebrides to the Loyalty Islands and New Caledonia. Speiser's (1923b, pp. 89-91) summary of linguistic evidence shows that no Melanesian language is entirely without Polynesian words, and Polynesian vocabulary has penetrated the New Hebrides to a considerable extent. Ray (1893, p. 102) remarks on considerable variation in the languages of the New Hebrides, and notes that these differences correspond to differences of the physique of the inhabitants. Anthropologists are today more cautious in their interpretations of linguistic evidence than in 1893, and would question the reliability of Ray's statement that "an examination of the languages shows that the inhabitants must be regarded as sprung, not from one, but several sources." Ray notes that in Efate and neighboring islands there are many Polynesian words. In Ambrym there are two dialects, but the language of Ambrym is difficult to connect; it seems to be a specialized Melanesian form.

Codrington (1885, pp. 7, 8) refers to scattered regions where Polynesian speech prevails, notably in Mea, one of the Loyalty Islands, in Futuna, a small island of the New Hebrides, in Tikopia, north of the Solomon Islands, and in Ontong Java, near Ysabel. He refers to the languages of these Melanesian islands as being "substantially that of Tonga (Polynesian), and the same throughout; speakers of the Maori of New Zealand can understand it and make themselves understood; it has nothing directly to do with the Melanesian languages." Physique and language may or may not be compatible. There are Melanesians who speak Polynesian, but in Tikopia both Polynesian physique and language prevail. Codrington (p. 16) refers to the language of Ambrym as being a "difficult and exceptional form of Melanesian." The Polynesian aspects of Tikopia have recently been described by Firth (1936).

Joly (1904, p. 366) refers to a party of shipwrecked Polynesians from Wallis Islands who landed in Ambrym and settled briefly at Point Deep. Speiser (1923b, p. 56) mentions this settlement among other drift landings in the New Hebrides about the period 1850-60, but offers the opinion that the Polynesians left no mark on the physique or culture of the people of Ambrym.

We have, apparently, no definite evidence of Polynesian influence, linguistic, cultural, or somatic, in the island of Ambrym, though we can be assured that such influence has been felt in some islands of

the New Hebrides, and in other widely separated parts of Polynesia as well. How then are we to account for the 14 "not significant" cranial differences, and for 28 differences which can be pooled as "not significant," "very small," and "medium"?

I do not believe that paucity of data and the size of the probable error of average measurements are the answer to our question, for even if the statistical method were discarded, we can see from the actual measurements in millimeters that all differences labeled "not significant" are indeed quite trifling. No doubt some allowance must be made for a fortuitous resemblance in some traits, no matter what samples of human skulls are compared, but in the comparison under discussion the resemblances seem too close and too numerous to be explained by chance.

The foregoing analysis by means of trait by trait comparison has indicated that the marked cranial differences between Negroes, Australians, and Melanesians are few. Moreover, there are a preponderating number of "not significant," "small," and "medium" differences, which, if pooled, enforce the impression of Negro, Melanesian, and Australian affinities. Furthermore, the similarities in Negro and Polynesian traits are by no means negligible, though the visual effect of them in forming a judgment is far outweighed by the "marked" differences.

It is by no means improbable that the explanation of all these cranial likenesses is to be found in the prehistorically remote contribution of Negro traits from a region that Sir Arthur Keith has referred to as the "Black Belt" of southern Asia.

VI. SUMMARY AND CONCLUSIONS (BY CHAPTERS)

I. *Introduction*

Tabular summary of the provenance of 429 Melanesian skulls in the collection of the Chicago Natural History Museum is followed by geographical notes. Photographs show natives of Ambrym to be of Negroid and Australoid types. The general appearance of the Ambrym skulls is given and sex differences are pointed out. These differences are well marked and sex division is not a difficult problem. After discussing literature relating to the determination of the ages of skulls a tabular statement gives the age grouping of 379 male and 160 female skulls of Melanesia. Analysis of these figures shows the great preponderance of male skulls, and the high incidence of mortality in the early age periods of 20-25, 25-30 years. This leads to a discussion of the causes affecting mortality among males and females, respectively, in primitive communities. These causes are both physical and psychological. Longevity is a comparatively modern achievement in the literate races, and each decade establishes a longer expectation of life.

II. *Technique*

The definitions and symbols of measurements are tabulated and discussed. Notes are given on a few changes in technique since the publication of *Craniometry of New Guinea* (Hambly, 1940). Experiment indicates that the ansteckgoniometer which is used in measuring the P angle gives results which do not differ significantly from those obtained with the stativgoniometer. The former instrument has the advantage of quicker adjustment and reading.

Experimental work was done in measuring cranial capacities with shot, sand, and mustard seed, and the differences in results were determined. This work will assist comparison of results reached by different workers. Experiment showed that a high degree of accuracy in measuring skull capacity by the mustard seed method can be attained by students working independently.

A note is given on the statistical method of comparing two averages in relation to their respective probable errors, in order to

judge the significance of the difference of the two averages. We can by this method give a rough idea of differences and resemblances in the series of skulls under comparison. Since the number of skulls from Ambrym is only 19, a trait by trait comparison with other series is perhaps more valuable than use of the coefficient of racial likeness.

III. *Sex Differences in Ambrym Skulls*

Excess of males over females in the small sample is in agreement with the proportions of the sexes in much larger cranial collections from Melanesia and elsewhere. The literature on this subject and reasons for male predominance are discussed. A summary is given relating to discussions on sex differences in human skulls. Contour drawings showing sex differences in Ambrym skulls are given, together with photographs. The sex ratio of traits is explained arithmetically, and sex ratios for three Melanesian populations are worked out. The sex ratio of traits shows little difference in these populations.

The magnitude of sex differences is examined and the alleged differences are found, with very few exceptions, to be significant. A table showing the comparative value of traits for distinguishing sex is given. The traits GLU and U are at the head of the table, with Δ/P_{Δ} values of 17.6 and 16.4 respectively, when average measurements for males and females are compared.

Measurements on eye sockets, palate, and foramen magnum are low on the list of values as sex determinants.

Sex differences between indices and angles are trivial, and so the racial type is preserved in both sexes. Sex differences are those of size, not of proportions and contours.

Study of variability of traits shows that on the whole variability is greater in males than in females. Males have an exceptionally high variability in the Egyptian "E" collection as compared with our Melanesian samples. For English skulls the variability of traits in the sexes is practically the same. Variability of traits varies by sex but to different degrees according to the racial sample under consideration.

IV. *Melanesian Cranial Types*

When such types are compared by contour drawings the general resemblances in outline are apparent, but the unreliability of such drawings for accurate representation of small differences must be emphasized.

For detailed comparative study of the skulls of Ambrym, New Guinea, and New Britain, all of which are Melanesian types, a table of average measurements and their probable errors is given.

Detailed analysis of the averages leads to a classification of trait differences as "not significant," "very small," "medium," and "marked." The basis of classification is the ΔP_{Δ} values which are obtained by dividing

$$M_1 - M_2 \text{ by } \sqrt{(PE_1)^2 + (PE_2)^2}.$$

The resemblances of Ambrym skulls to those of New Britain (Gazelle Peninsula) is much closer than the resemblances between the New Guinea and Ambrym samples. Out of 45 traits selected for comparison of Melanesian skulls of Ambrym and New Britain, 38 are so close that their differences are "not significant." Photographs indicate that the Ambrym and New Britain skulls are both of an Australoid type.

Comparison of Ambrym and New Guinea skulls indicates that 22 out of 45 traits have average measurements that show no significant differences. The "marked" differences are bizygomatic width, breadth of nose, length of palate, and length of the eye socket.

A trait by trait comparison of New Guinea and New Britain skulls indicates that only 9 traits out of 44 show no marked difference.

The appearance and measurements of the skulls suggest that, whereas the Ambrym and New Britain samples are much alike, and they are both of Australoid pattern, the New Guinea skulls are more of a Negro type. These inferences are tested in the next chapter by detailed comparison of skull samples from East Africa, Australia, and the Melanesian areas of Ambrym, New Guinea, and New Britain.

Finally, in the comparison of Melanesian samples a table is given to summarize the resemblances of the Ambrym, New Guinea, and New Britain series. For these three Melanesian regions 20 traits out of 42 are so alike that the figures expressing the average values are, statistically at any rate, not significant. If we consider the fundamental resemblances in size, proportions, and angles we realize that there is enough likeness to establish a visual impression of close similarity between the skulls of Ambrym, New Britain, and New Guinea.

V. *Australoid, Negro, and Polynesian Traits in Ambrym Skulls*

In this chapter the aim was to make a trait by trait comparison of the average measurements of skulls from Ambrym, Australia,

Negro Africa, and Polynesia. The coefficient of racial likeness, which expresses briefly a relationship that includes both differences and resemblances, was not used because of the small number of skulls in the Ambrym group.

A possible objection to trait by trait comparison, on the ground that skull traits are closely correlated, and that some may be more important than others as racial characters, was discussed. It would seem, however, that a uniform kind of correlation between parts of skulls is operative throughout all the series, and for this reason correlation need not be regarded too seriously as a disturbing factor in making our comparisons.

With regard to the relative importance of traits as group criteria, information is not definite, but trait analysis of the kind attempted in this publication clearly distinguishes some cranial attributes that are more important than others for purposes of demarcation.

Before approaching the main problem of discovering the main likenesses and unlikenesses of Ambrym skulls some preliminary experiment was thought to be necessary in order to establish datum lines of likeness and unlikeness.

The lowest degree of likeness found between any two samples of skulls was that existing between a New Britain and an Old London series, for which only 2 out of 27 traits had "not significant" differences. The same low degree of resemblance was found between a series of New Guinea and Old London skulls. Other resemblances of a low order were Maori-Old London for which the likeness ratio was 5:27. That is to say, 5 out of 27 traits showed a difference that was not significant. The trait ratio of Australian and Old London skulls is 4:27. We do not know to what extent resemblances of the "not significant" type may arise merely from the fact that, despite differentiation into cranial types, all human skulls are traceable along lines of a common human ancestry.

But, although we cannot draw a firm line of demarcation, we certainly reach degrees of biometric resemblance which, considered in conjunction with visual impressions of living subjects and series of crania, support theories of racial affinity.

The closest relationship discovered in these preliminary experiments of trait by trait comparison is that existing between Negro skulls of East Africa and those of Australia, which show 19 out of 27 traits that have no significant difference. A likeness of this kind (70.4 per cent) cannot be explained as fortuitous. Despite the obvious differences in general physique, skin color, hirsuteness,

hair texture, and the development of brow ridge and glabella, the basic likeness of Negro and Australian skulls is genuine. By genuine I mean of phylogenetic significance, and not spurious in the sense that resemblances might easily arise because average measurements for all human skulls must lie within certain rather restricted limits. We then turn to the specific problem of the biometric relationships of Melanesian skulls from Ambrym.

Briefly we may say:

- (1) The skulls of Ambrym bear their strongest likeness to those of Australia, with 26 out of 41 traits showing no significant differences. This is a 63.4 per cent resemblance. The only "marked" differences are the breadth of the face (J), and the A and N angles of the facial triangle.
- (2) Ambrym skulls have 31 out of 41 (75.6 per cent) traits showing resemblance to Negro skulls when judged by the "not significant" differences. This would at first glance indicate that the Ambrym skulls have greater affinity with the Negro than with the Australian, a judgment that belies our visual impression. The apparent contradiction of visual judgment and biometric comparison is explained by consultation of the column of "marked" differences. Such differences are 7 in number for the Ambrym-Negro comparison, and only 3 for the Ambrym-Australian comparison.
- (3) The Ambrym (Melanesian), Negro, and Australian measurements form a strong triangular connection in which, so I surmise, the Negro traits are a basic plexus, entrenched far back in human history. It will be recalled that trait comparison of Australian and Negro skulls showed a relationship of 19:27. There are 22 out of 41 traits linking the tripartite comparison of Negroes, Australians, and Melanesians of Ambrym.
- (4) The Ambrym skulls have a relatively large number of "marked" differences from the "pooled Polynesian" skulls. There are 13 of these "marked" differences, but the number of "not significant," "very small," and "medium" differences is somewhat surprising. Our visual impression would decidedly be one of great disparity between skulls of Ambrym and those of Polynesia, and this is a valid impression since the eye will readily seize upon 13 marked differences, whereas a larger number of resemblances may be overlooked. Research shows that Ambrym might easily have been affected by Polynesian

influence, linguistic, cultural, and somatic, but there is no good evidence that such influence actually occurred.

- (5) A final comparison of average measurements for Ambrym, Australian, Negro, and Polynesian skulls reveals 9 traits as connecting links common to all series, but there are 7 "marked" differences in traits for which no agreement whatever can be found.
- (6) From consideration of the columns of "marked" differences I draw the inference that Nature in her phylogenetic experiments stresses a few differences, while many traits emerge with differences "not significant," "very small" or "medium."

The results of present research on the skulls of Ambrym therefore suggests the disparity which exists between the value of traits as determinants of race. This confirms the conclusions drawn when working with the New Guinea series (Hambly, 1940, p. 250), where the traits are arranged according to their value as criteria.

We can be reasonably sure that the A and N angles of the facial triangle are valuable criteria of race, or—since the word "race" is in such disrepute—shall we say of cranial groups. On the contrary, the B angle of that triangle maintains a relatively constant value when we turn from one group to another. The P angle which, like the A angle, measures prognathism, is also a useful distinguishing feature. The absolute breadth of the skull (better than the length) is a distinguishing trait. The nasal measurements are useful criteria. On the contrary the minimum frontal diameter shows much uniformity in the samples we have considered, and so do the measurement for the foramen magnum.

It would be fallacious to suppose that these inferences, derived from a study of a few groups, would apply to the comparison of other groups of different ethnic affinities that are widely separated geographically. Nevertheless, I believe that craniometrists will at some future time make a clearer division between traits that have a determining and characterizing value and those which seem to serve mainly as general determinants of human skulls.

Our general conclusion is that Ambrym skulls are strongly Australoid, somewhat less strongly Negroid, and that throughout Australian, Melanesian, and even Polynesian series, there are impressive Negroid homologies. These may be traceable far back in time and place to a proto-Negro ancestry that laid many of the cranial foundations before the wide dispersal and differentiation of the so-called "races of mankind."



APPENDIX 1: AMBRYM CRANIA IN COLLECTION OF
CHICAGO NATURAL HISTORY MUSEUM

TABLES OF MEASUREMENTS OF INDIVIDUAL SKULLS, MALES AND FEMALES,
AND AVERAGE MEASUREMENTS FOR ALL TRAITS



FEMALE SKULLS FROM AMBRYM, NEW HEBRIDES

Catalogue number	Age	Capacity in cc.	L	B	B'	H'	LB	St	St'	S ₂	S ₂ '	S ₃	S ₃ '
43057	20-25	1188	166	125	88	124	86	115	101	133	114	106	92
43088	20-25	1068	162	121	85	122	90	114	102	122	109	93	82
43065	35-40	1238	170	132	88	129	91	123	109	130	113	111	97
43069	45-50	1101	173	129	89	132	94	122	106	119	109	111	95
43059	50+	1252	174	128	92	132	94	117	106	132	115	106	93
43089	30-35	1120	170	123	90	125	95	116	101	134	115	100	89
43058	20-25	1329	182	124	120	131	96	123	110	138	125	105	90
43061	25-30	1043	166	121	87	120	94	103	94	130	113	98	86
43074	20-25	1153	176	127	95	123	92	119	104	127	112	105	87
43078	45-50	1365	185	126	97	138	98	130	114	144	126	115	98
43092	50+	1162	175	124	91	129	88	123	106	125	113	116	97
Averages...			172.6	125.4	90.2	127.7	92.5	118.6	104.8	130.4	114.9	106.0	91.4
			±20.07	±0.66	±0.68	±1.05	±0.69	±1.35	±1.04	±1.38	±1.09	±1.37	±1.00

Catalogue number	Age	S	GLU	U	BQ'	GB	J	G'H	GL	NHR	NHL	NH'	NB
43057	20-25	354	475	470	275	81	116	65.0	96	44.8	45.2	45.0	24.8
43088	20-25	329	465	455	277	85	...	59.9	97	42.5	43.2	42.0	23.8
43065	35-40	364	488	482	300	84	119	59.2	94	45.8	45.8	46.0	26.0
43069	45-50	352	480	477	294	90	124	62.0	96	43.0	44.2	43.5	26.8
43059	50+	355	492	483	295	90	129	...	93	48.1	46.5	47.3	27.0
43089	30-35	350	480	470	270	84	120	59.0	96	44.1	44.1	42.6	28.1
43058	20-25	366	503	494	287	92	124	67.4	100	52.3	52.3	51.9	27.0
43061	25-30	331	475	465	262	92	120	61.3	106	46.5	47.5	44.5	26.2
43074	20-25	351	495	490	295	91	120	65.4	96	47.5	47.5	46.1	25.4
43078	45-50	389	515	510	293	91	124	70.0	100	48.0	48.0	48.9	21.7
43092	50+	364	483	480	290	90	123	52.0	89	44.0	44.1	44.0	23.0
Averages....			486.4	479.6	285.3	88.2	121.9	62.1	96.6	46.0	46.2	45.6	25.4
			±3.28	±2.92	±2.39	±0.75	±0.74	±1.03	±0.84	±0.63	±0.50	±0.56	±0.38

FEMALE SKULLS FROM AMBRYM, NEW HEBRIDES—Continued

Catalogue number	Age	OxR	OxL	OxR	OxL	OxL	OxR	OxL	OxL	OxL	OxL	Lac OxR	Lac OxL	DC	G ₁	G ₂	G ₁ '
43057	20-25	39.4	33.8	37.2	34.0	36.3	37.0	35.0	35.0	18.0	50.6	39.0	49.0				
43088	20-25	37.5	33.0	34.9	30.9	36.0	35.5	34.9	35.0	19.2	50.5	40.5	46.5				
43065	35-40	38.8	30.5	38.6	30.1	37.6	36.1	35.1	35.0	21.0	51.2	38.2	46.1				
43069	45-50	41.8	33.1	40.2	32.3	38.2	33.2	37.0	38.0	20.5	50.6	40.0	49.0				
43059	50+	41.2	35.0	42.3	33.3	39.3	41.2	37.0	38.0	22.0	50.6	40.0	49.0				
43089	30-35	39.9	34.1	38.1	32.2	38.1	36.2	35.0	35.0	22.2	51.0	38.0	44.1				
43058	20-25	42.1	33.3	40.0	32.1	39.0	38.4	38.6	38.2	21.4	50.8	43.0	45.0				
43061	25-30	41.2	32.8	43.0	29.8	39.5	38.9	39.9	38.5	19.0	60.0	40.0	55.0				
43074	20-25	41.8	35.0	40.9	35.6	39.1	41.5	38.9	38.9	19.7	54.0	45.5	47.0				
43078	45-50	43.0	36.0	41.4	35.5	40.3	39.9	39.8	39.1	22.6	58.5	39.2	48.2				
43092	50+	42.8	33.2	43.5	33.3	40.7	41.2	40.6	40.6	18.0	45.3	43.1	40.0				
Averages.....		40.9	33.6	40.0	32.6	38.5	38.1	37.7	38.3	20.3	52.0	40.6	47.0				
		±0.34	±0.28	±0.51	±0.39	±0.29	±0.53	±0.51	±0.40	±0.31	±0.74	±0.47	±0.79				

Catalogue number	Age	EH	fml	fmb	100B-L	100H-L	100B-H'	100(B-H)	Oel	100GH-GB	100NB-NH'	100NB-NH'	100B-NH'
43057	20-25	13.0	33.2	27.0	75.3	74.7	100.1	+0.6	64.7	80.2	55.3	55.1	
43088	20-25	9.0	38.0	30.9	74.7	75.3	99.2	-0.6	67.3	70.5	56.0	56.7	
43065	35-40	10.0	34.1	28.8	74.6	75.9	102.3	+1.8	65.8	70.5	56.8	56.5	
43069	45-50	12.0	33.0	28.9	74.6	76.3	97.7	-1.7	62.9	68.9	62.3	61.6	
43059	50+	36.2	29.8	73.6	75.9	97.0	-2.3	66.4	68.9	56.1	57.1	
43089	30-35	32.0	27.5	72.3	73.5	98.4	-1.2	69.3	70.2	63.7	66.0	
43058	20-25	13.0	39.5	29.5	68.1	72.0	94.6	-3.8	63.0	73.3	51.6	52.0	
43061	25-30	11.0	35.2	32.0	72.9	72.3	100.8	+0.6	66.6	66.6	56.3	58.9	
43074	20-25	13.7	36.0	25.0	72.1	69.9	103.2	+2.3	59.5	71.9	53.5	55.1	
43078	45-50	16.9	31.9	28.2	68.1	74.6	91.3	-6.5	76.9	76.9	45.2	44.4	
43092	50+	33.3	28.0	70.8	73.7	96.1	-2.8	60.3	57.8	52.3	52.3	
Averages.....		12.3	34.8	28.7	72.5	74.0	98.2	-1.2	64.4	70.7	55.4	56.0	
		±0.55	±0.48	±0.37	±0.49	±0.38	±0.67	±0.39	±0.59	±1.21	±0.89	±1.07	

FEMALE SKULLS FROM AMBRYM, NEW HEBRIDES—Continued

Catalogue number	Age	$\frac{100O_2R}{O_1R}$	$\frac{100O_2R}{LacO_2R}$	$\frac{100G_2}{G_1}$	$\frac{100G_2}{G_1'}$	$\frac{100EH}{G_2}$	$\frac{100fmb}{fml}$	A Z	B Z	N Z	P Z	Pros. P.Z	Weight in gms.
43057	20-25	93.1	93.9	77.1	79.6	33.3	81.3	61	41	78	75.0	73.8	478
43088	20-25	91.7	94.5	80.2	87.1	22.2	81.3	65	38	77	77.0	75.5	422
43065	35-40	81.1	86.9	74.6	82.9	26.7	84.4	67	38	75	84.0	81.5	548
43069	45-50	86.6	89.4	79.2	81.6	30.0	87.6	69	38	73	81.8	78.0	508
43059	50+	89.0	82.3	377
43089	30-35	89.5	74.5	86.2	86.6	71	37	72	82.0	79.5	357
43058	20-25	85.4	86.3	84.6	95.5	30.2	74.7	68	40	72	79.0	77.5	475
43061	25-30	83.0	82.2	66.7	72.7	27.5	90.9	62	34	84	75.0	71.0	426
43074	20-25	89.5	84.1	96.6	30.2	69.4	66	41	73	83.0	82.5	565
43078	45-50	89.3	90.4	69.4	81.3	43.1	88.4	67	41	72	81.0	79.2	427
43092	50+	81.6	81.8	95.1	107.7	84.1	71	34	75	83.0	82.5	333
Averages.....													
		± 0.78	± 1.07	± 1.66	± 2.06	± 1.36	± 1.21	± 0.68	± 0.54	± 0.76	± 0.69	± 0.64	446.9 ± 14.64

MALE SKULLS FROM AMBRYM, NEW HEBRIDES

Catalogue number	Age	Capacity in cc.	L	B	B'	H'	LB	Si	S'	S ₂	S ₂ '	S ₃	S ₃ '
43080	25-30	1466	178	138	89	134	99	131	118	127	112	106	92
43056	30-35	1378	184	133	96	127	98	124	109	130	117	113	92
43062	35-40	1313	187	128	93	136	101	126	113	138	125	113	94
43063	40-45	1345	188	137	98	130	99	126	111	139	123	121	96
43060	25-30	1424	184	135	95	138	100	125	113	135	119	122	96
43064	35-40	1250	176	131	93	126	97	121	108	135	117	109	93
43067	40-45	1359	190	134	99	134	99	132	115	131	116	123	97
43066	25-30	1343	180	127	93	135	100	122	110	136	117	112	93
43077	45-50	1143	181	122	96	130	100	114	107	135	120	112	90
43068	40-45	1345	174	134	86	125	89	122	105	125	109	110	91
43070	50+	1338	178	130	92	128	89	120	104	133	115	122	101
43071	50+	1254	184	130	91	134	105	115	104	141	122	113	94
43072	40-45	1432	195	128	99	139	108	125	111	160	138	110	92
43076	40-45	1472	199	137	95	134	103	135	114	150	133	125	89
43092	50+	1129	174	127	97	120	93	128	112	120	107	116	92
43073	45-50	1286	179	127	94	130	93	125	106	127	112	121	101
43087	45-50	1201	179	128	97	137	106	117	105	138	119	105	91
43083	50+	1460	187	134	97	129	98	121	109	133	118	121	97
43086	40-45	1256	180	128	95	132	102	128	115	130	114	111	99
43084	40-45	1181	171	131	89	126	99	126	114	116	103	103	90
Averages.....			182.4	130.9	94.2	131.2	98.9	124.1	110.1	133.9	117.8	113.9	94.0
			±1.05	±0.61	±0.51	±0.73	±0.74	±0.80	±0.63	±1.43	±1.19	±0.97	±0.53
			±15.46										

MALE SKULLS FROM AMBRYM, NEW HEBRIDES—Continued

Catalogue number	Age	S	GLJ	U	BQ'	GB	J	G'H	GL	NHR	NHL	NH'	NB
43080	25-30	364	512	505	310	97	141	73.5	104	52.0	52.1	53.1	25.0
43056	30-35	367	512	508	300	101	136	72.0	103	54.0	54.0	51.0	27.0
43062	35-40	377	528	506	306	103	139	70.0	110	55.7	55.1	53.1	29.0
43063	40-45	386	538	529	300	104	140	72.2	104	55.1	54.0	56.2	29.0
43060	25-30	382	524	508	306	97	134	66.0	99	45.1	47.0	46.7	23.1
43064	35-40	365	495	490	302	99	132	66.0	107	49.0	49.6	46.2	30.0
43067	40-45	386	530	520	311	99	134	72.0	109	50.2	51.2	50.0	26.8
43066	25-30	370	498	492	300	97	...	63.0	108	49.0	47.0	47.0	28.7
43077	45-50	361	508	490	270	97	140	71.2	104	53.1	52.5	52.0	27.0
43068	40-45	357	502	482	290	98	131	67.7	99	47.9	50.5	51.8	27.2
43070	50+	375	510	497	294	93	135	43.0	43.4	44.0	27.9
43071	50+	369	525	504	300	100	136	66.5	106	49.5	50.0	50.3	28.0
43072	40-45	395	544	534	305	102	138	71.9	109	53.6	52.7	54.8	27.5
43076	40-45	410	552	542	305	94	140	71.3	107	49.5	49.9	50.2	25.7
43092	50+	364	500	490	288	95	...	65.0	103	49.0	49.8	49.5	30.0
43073	45-50	373	510	498	287	95	133	67.7	101	46.6	50.1	50.1	27.2
43087	45-50	360	505	495	285	103	136	70.0	111	48.1	50.0	49.8	25.1
43083	50+	375	525	515	303	96	141	63.0	99	50.8	51.2	50.8	29.0
43086	40-45	369	515	496	295	97	133	69.1	109	51.1	52.1	51.5	29.6
43084	40-45	345	500	480	293	96	132	71.0	108	48.2	51.2	49.0	26.2
Averages.....		372.5	516.6	504.0	297.5	98.1	136.2	68.9	105.3	50.0	50.7	50.3	27.4
		±2.12	±2.36	±2.84	±1.46	±0.47	±0.53	±0.49	±0.58	±0.48	±0.40	±0.43	±0.27

MALE SKULLS FROM AMBRYM, NEW HEBRIDES—Continued

Catalogue number	Age	O ₁ R	O ₂ R	O ₁ L	O ₂ L	O ₁ R	O ₁ L	O ₁ T	O ₂ L	O ₁ T	I ^{Lac} O ₁ R	I ^{Lac} O ₁ L	DC	G ₁	G ₂	G ₁ '
43080	25-30	45.0	35.8	44.2	35.8	43.0	43.0	43.0	39.0	41.0	39.0	41.0	21.5	54.7	41.8	49.0
43056	30-35	45.2	33.5	44.0	34.7	42.7	43.1	43.1	42.9	41.0	42.9	41.0	22.1	55.3	46.5	51.6
43062	35-40	45.1	35.6	43.2	35.5	41.9	41.6	41.6	40.8	41.1	40.8	41.1	23.9	60.5	44.8	58.5
43063	40-45	44.0	32.5	42.0	31.8	40.9	39.5	39.5	42.2	39.8	42.2	39.8	28.0	58.6	45.5	53.6
43060	25-30	43.2	29.0	43.0	28.0	40.8	40.8	40.8	39.0	41.0	39.0	41.0	20.7	52.8	40.0	49.9
43064	35-40	40.5	31.2	41.1	31.5	39.0	40.3	40.3	37.5	38.8	37.5	38.8	21.0	57.1	41.0	54.5
43067	40-45	41.0	33.5	41.2	32.3	41.0	38.2	38.2	37.3	37.2	37.3	37.2	26.5	62.0	38.0	57.2
43066	25-30	32.0	44.3	31.0	40.8	40.8	39.5	39.5	20.2	64.0	43.0	51.8
43077	45-50	44.8	36.0	46.0	35.5	43.2	42.4	42.4	41.2	41.1	41.2	41.1	25.2	61.0	42.0	56.1
43068	40-45	42.7	36.3	41.6	35.4	41.2	41.6	41.6	38.9	40.1	38.9	40.1	21.1	52.8	39.9	48.9
43070	50+	40.8	35.2	42.0	34.3	39.5	40.9	40.9	40.1	40.1	22.2
43071	50+	41.3	34.9	42.0	34.2	41.0	40.2	40.2	40.8	40.0	40.8	40.0	22.3	59.1	44.1	51.2
43072	40-45	43.8	34.2	40.1	34.8	41.2	39.0	39.0	39.1	38.5	39.1	38.5	25.1	56.4	46.5	52.1
43076	40-45	41.6	33.1	41.9	35.0	40.5	40.0	40.0	38.5	37.9	38.5	37.9	23.3	56.2	46.1	54.1
43092	50+	46.8	31.2	45.4	29.8	43.2	42.3	42.3	42.2	41.3	42.2	41.3	22.0	58.0	49.0	55.0
43073	45-50	42.4	36.8	42.9	37.6	41.0	40.6	40.6	38.1	40.1	38.1	40.1	20.5	40.0	51.5
43087	45-50	43.2	32.3	40.6	31.2	40.5	39.8	39.8	39.6	39.0	39.6	39.0	23.0	59.4	42.2	55.5
43083	50+	44.2	34.1	46.2	36.1	41.5	43.3	43.3	39.2	41.5	39.2	41.5	20.3	53.0	42.1	49.1
43086	40-45	43.1	34.0	44.0	34.1	42.0	41.2	41.2	39.8	41.0	39.8	41.0	22.9	61.0	47.0	56.0
43084	40-45	44.2	32.0	43.0	32.0	40.2	42.0	42.0	39.3	40.1	39.3	40.1	19.7	55.5	39.3	53.1
Averages.....		43.3	33.7	42.9	33.5	41.3	41.0	41.0	39.7	40.0	39.7	40.0	22.6	57.6	43.1	53.1
		±0.26	±0.30	±0.43	±0.36	±0.18	±0.20	±0.20	±0.25	±0.18	±0.25	±0.18	±0.33	±0.51	±0.47	±0.43

MALE SKULLS FROM AMBRYM, NEW HEBRIDES—Continued

Catalogue number	Age	EH	fml	fmb	$\frac{100B}{L}$	$\frac{100H'}{L}$	$\frac{100B}{H'}$	$\frac{100(B-H')}{L}$	OcI	$\frac{100G'H}{GB}$	$\frac{100NB}{NHR}$	$\frac{100NB}{NH'}$	$\frac{100O'R}{O'R}$
43080	25-30	14.0	36.2	32.8	77.5	75.3	103.0	+2.2	64.7	75.8	48.1	47.1	79.5
43056	30-35	14.5	34.0	26.5	72.3	69.0	104.7	+3.3	58.2	71.3	50.0	52.9	74.1
43062	35-40	13.9	35.5	31.3	68.4	72.7	94.1	-4.3	59.8	68.0	52.1	54.6	78.9
43063	40-45	13.0	34.8	27.0	72.9	72.2	105.4	+3.7	56.6	69.4	52.6	51.6	73.9
43060	25-30	10.0	36.5	32.0	73.4	75.0	97.8	-1.6	56.2	68.0	51.2	49.5	67.1
43064	35-40	29.2	25.0	74.4	71.6	104.0	+2.8	62.4	66.7	61.2	64.9	77.0
43067	40-45	13.8	35.2	24.0	70.5	70.5	100.0	0.0	56.3	72.7	53.4	53.6	81.7
43066	25-30	12.4	35.8	27.8	70.5	75.0	94.1	-4.4	59.7	64.9	58.6	61.1
43077	45-50	17.0	37.5	30.1	67.4	71.8	93.8	-4.4	57.3	73.4	50.8	51.9	80.3
43068	40-45	35.0	29.0	77.0	71.8	107.2	+5.2	59.6	69.1	56.8	52.5	85.0
43070	50+	33.7	30.1	73.0	71.9	101.6	+1.1	59.4	64.9	63.4	86.3
43071	50+	34.0	29.5	70.6	72.8	97.0	-2.2	59.8	66.5	56.6	55.7	84.5
43072	40-45	19.0	35.5	27.0	65.6	71.3	92.1	-5.6	60.3	70.5	51.3	50.2	78.1
43076	40-45	16.5	37.1	28.2	68.8	67.3	92.1	+1.5	53.4	75.8	51.9	51.2	79.6
43092	50+	31.0	24.3	73.0	69.0	105.8	+4.0	56.6	68.4	60.6	60.6	66.7
43073	45-50	32.2	32.1	70.9	72.6	97.7	-1.7	60.1	71.3	58.4	54.3	86.8
43087	45-50	13.9	37.2	31.0	70.9	76.5	93.4	-5.0	64.5	68.0	52.2	50.4	74.8
43083	50+	36.0	29.0	71.6	69.0	103.9	+2.7	57.2	65.6	57.1	57.1	77.1
43086	40-45	17.0	32.0	30.2	71.1	73.3	97.0	-2.2	69.6	71.2	57.9	57.5	78.9
43084	40-45	13.9	31.0	27.2	76.6	73.7	104.0	+2.9	65.8	73.9	54.3	53.5	72.4
Averages....		14.5	34.5	28.7	71.8	72.1	99.4	-0.10	59.9	70.0	55.0	54.7	78.0
		± 0.42	± 0.34	± 0.38	± 0.45	± 0.36	± 0.75	± 0.22	± 0.57	± 0.49	± 0.65	± 0.70	± 0.86

MALE SKULLS FROM AMBRYM, NEW HEBRIDES—Continued

Catalogue number	Age	1000:R O:R	1000:R LacO:R	100G ₂ G ₁	100G ₂ G ₁ '	100EH G ₂	100fmb fml	A Z	B Z	N Z	P Z	Pros. P Z	Weight in grms.
43080	25-30	83.2	91.8	76.4	85.3	33.5	90.6	65	42	73	84.2	82.7	412
43056	30-35	78.4	78.1	84.1	90.1	31.2	77.9	65	42	73	78.2	76.5	571
43062	35-40	85.0	87.3	74.0	76.6	31.0	88.2	64	38	78	75.2	73.0	747
43063	40-45	79.5	77.0	77.6	84.9	28.6	77.6	64	42	74	80.0	77.2	819
43060	25-30	71.1	74.4	75.7	80.2	25.0	87.7	71	39	70	88.9	86.2	663
43064	35-40	80.0	83.2	71.8	75.2	85.6	63	37	80	82.0	81.3	585
43067	40-45	81.7	89.8	61.3	66.4	36.3	68.2	63	39	78	80.0	78.8	789
43066	25-30	67.2	83.0	28.8	77.6	65	35	80	72.0	71.8	564
43077	45-50	83.3	87.4	68.8	74.9	40.5	80.3	67	41	72	79.5	77.6	632
43068	40-45	88.1	93.3	75.6	81.6	82.8	63	41	76	80.9	77.5	488
43070	50+	89.1	89.3	429
43071	50+	85.1	85.5	74.6	86.1	86.8	72	37	71	78.2	77.2	720
43072	40-45	83.0	87.5	82.4	89.2	40.9	76.0	69	39	72	81.2	79.5	660
43076	40-45	81.7	86.0	82.0	85.2	35.8	76.0	68	40	72	74.0	71.6	708
43092	50+	72.2	73.9	84.5	89.1	78.4	62	38	80	77.4	76.4	549
43073	45-50	89.7	96.6	77.7	99.7	64	40	76	73.0	70.0	555
43087	45-50	79.7	81.6	71.0	76.0	32.9	83.3	67	37	76	80.5	79.5	605
43083	50+	82.2	87.0	79.4	85.6	80.5	70	38	72	85.0	81.5	585
43086	40-45	80.9	85.4	77.0	83.9	36.2	94.4	66	38	76	80.5	78.5	626
43084	40-45	79.6	81.4	70.8	74.0	35.4	87.7	64	40	76	83.4	81.3	508
Averages....		81.8	84.8	75.2	81.3	33.5	83.4	65.9	39.1	75.0	79.7	77.8	610.7
		±0.89	±0.97	±0.95	±0.95	±0.84	±1.09	±0.44	±0.30	±0.48	±0.64	±0.61	±15.53

APPENDIX 2: RACIAL CHARACTERS OF LOWER JAW
AND TEETH



RACIAL CHARACTERS OF LOWER JAW AND TEETH

LOWER JAW

The studies of Hrdlička (1940) on the lower jaw show some resemblances and differences between Negroes, Melanesians, and Australian aborigines. The following table, which has been compiled from Hrdlička's data, includes his observations on the lower jaws of Melanesian skulls in the Chicago Natural History Museum collection.

MEASUREMENTS OF LOWER JAW: MALES

Measurement	Negro	Australian	Melanesian
Bigonial diameter	95.8 (30)	103.4 (17)	96.5 (153 miscellaneous) 94.6 (New Caledonia 17, New Hebrides 13)
Gonial angle	120.5° (28)*	117.0° (59)	112.5° (124)
Symphyseal height	33.5 (30)	31.5 (11)	32.0 (33)
Length of body of lower jaw	99.0 (27)*	103.0 (4)	99.6 (124, mainly from New Britain, New Guinea, New Hebrides)
Height of ascending portion of jaw	62.0 (27)*	62.0 (4)	65.7 (124, mainly from New Britain, New Guinea, New Hebrides)
Breadth of ascending portion of jaw	38.0 (30)*	34.0 (76)	38.7 (33 mixed Melane- sians)

Measurements are in millimeters. The asterisk denotes that the sample contains mixed measurements from African Negroes and from American full-blooded Negroes. Figures in parentheses indicate number of measurements made.

Hrdlička concludes in general that the lower jaw offers valuable group, age, sex, and other variations. Gonial angles are by no means closely alike in human groups, or even in all the groups of one human stock. The angle is in the main highest (most oblique) in White people and lowest for some of the American Indians. As a rule the average measurement of the gonial angle is higher for females than for males; but this observation has a very limited value for determining the sex of one individual.

Negroes and Melanesians have about the same bigonial diameter, the same length of body (horizontal ramus), and the same breadth of ascending ramus. Negroes, Australians, and Melanesians have practically the same symphyseal height. Negroes and Australians have the same height of ascending ramus.

Despite the paucity of data for some samples, we see in the lower jaws of the three racial divisions some likenesses that agree well with resemblances of Australian, Melanesian, and Negro crania that have been tabulated and discussed in this publication (chap. V).

RACIAL CHARACTERS OF TEETH

A detailed survey of the racial characters of teeth would extend this publication far beyond the scope intended, for the subject of dentition has a vast bibliography. The wealth of literature bearing on this subject is indicated by Krogman's bibliography (1941, pp. 157-162), and another long bibliography is given in the index volumes of the *American Journal of Physical Anthropology*.

Hrdlička (1939, pp. 142-144) and Martin (1928, vol. 2, pp. 669-670, 985-991) summarize the technique of observation that should be followed, and in making measurements of molars and premolars on Ambrym skulls Dr. Dahlberg followed the definitions of Hrdlička (1939, p. 143).

In the extensive literature, measurements on teeth seem to play a secondary part, but Duckworth (1904a, p. 122) quotes his measurements on the molars and premolars of a small number of Australian aborigines. Duckworth's studies of teeth (1904b) are mainly descriptive.

Hellman (1928) makes a study of the racial characters of dentition but this again is chiefly non-metrical. Perhaps the most useful works for the metrical study of teeth of Negroes and of Australians are those of Shaw (1931) for the South African Bantu, and of Campbell and Gray (1936) and Campbell (1925) for the Australians.

The data of Shaw are based on the study of 132 Bantu skulls of South African tribes, and of these skulls 98 were males, 20 were females, and the sex of the remainder was undetermined. In addition to this source Shaw considered 2,057 extracted teeth of which the sex was unknown. All the teeth were those of adults. Shaw makes no distinction between teeth from right and left sides, but he separates his data for upper and lower teeth. He states that Campbell, when measuring teeth of Australian aborigines, found a separation of data for the sexes to be impracticable. Therefore, in

accordance with these precedents Dr. Dahlberg pooled the measurements for teeth of males and females of Ambrym before preparing a table of comparisons based on the data given by Shaw.

The statement of Hrdlička (1939, p. 114) in some measure supports the pooling of measurements for teeth of both sexes. He says: "Teeth are not very good criteria for sex differentiation. On the whole the female teeth tend to be slightly to moderately smaller in all dimensions, but there are numerous exceptions to this both in primitive and civilized peoples."

Measurements taken on teeth in situ on the Ambrym skulls (table, p. 84) indicate that the sex differences are small.

Some students may question the advisability of recording measurements on single teeth, and may ask why, when teeth are in situ, as in the case of the Ambrym skulls, the observer does not record length of molars and of premolars. Unfortunately, a pre- and post-mortem loss of teeth leaves only a few jaws in which linear measurement of this kind is possible, and there is no justification for making a total measurement if one or more teeth are missing.

The tables of measurements of teeth of different races (p. 85) bring out the following points:

- (1) The Bushmen have the smallest teeth, and the modern Whites have teeth almost as small.
- (2) Australian aborigines have the largest teeth.
- (3) The molar teeth of Melanesians of Ambrym have measurements in close agreement with those recorded for natives of New Britain.
- (4) Total length of molars and of premolars in the lower jaw is slightly in excess of the corresponding measurement in the upper jaw, and the excess is nearly the same for all racial samples considered.
- (5) The upper teeth show an excess width over the lower teeth.

Comparison of the size of teeth in racial samples leaves much opportunity not only for the collation of further data, but for detailed discussion of technique and for the adoption of some standards of comparison, such as size of teeth in relation to palatal width and length, so that one may avoid making absolute comparisons of dental lengths and widths. This of course would require the standardization of palatal measurements, and only the sizes of teeth measured in situ would be acceptable for calculating a ratio of dental and palatal measurements.

Dr. W. M. Krogman (1927) published an article containing data relating to Melanesian dentition with special reference to occlusion. During this work Dr. Krogman examined the Melanesian collections in Chicago Natural History Museum. This research is now being continued by Dr. A. A. Dahlberg of Chicago, and this appendix should be regarded merely as a prefatory note.

AVERAGE MEASUREMENTS OF AMBRYM TEETH

Measurements Made by Dr. A. A. Dahlberg, Research Associate

Sex	<i>Upper Jaw</i>									
	PM ₁		PM ₂		M ₁		M ₂		M ₃	
	L	B	L	B	L	B	L	B	L	B
Males	(14)	(14)	(15)	(15)	(20)	(20)	(18)	(18)	(18)	(18)
	7.3	10.3	6.8	10.1	11.1	12.6	10.2	12.5	8.9	11.8
	(7)	(7)	(9)	(9)	(18)	(18)	(17)	(17)	(7)	(7)
Females	7.1	10.0	6.6	10.0	10.8	12.2	10.1	12.1	9.1	12.0
Males and } females }	(21)	(21)	(24)	(24)	(38)	(38)	(35)	(35)	(25)	(25)
	7.2	10.2	6.7	10.1	11.0	12.4	10.1	12.4	9.0	11.9

	<i>Lower Jaw</i>							
	M ₁		M ₂		M ₃			
	L	B	L	B	L	B	L	B
Males	(6)	(6)	(4)	(4)	(7)	(7)	(7)	(7)
	11.7	11.0	11.3	10.7	11.7	10.5	10.5	10.5
	(7)	(7)	(8)	(8)	(10)	(10)	(10)	(10)
Females	11.4	10.7	10.8	10.5	11.3	10.5	10.5	10.5
	(13)	(13)	(12)	(12)	(17)	(17)	(17)	(17)
Males and females	11.6	10.8	11.0	10.6	11.5	10.5	10.5	10.5

AVERAGE MEASUREMENTS OF MELANESIAN TEETH (NEW BRITAIN)*

Sex	<i>Upper Jaw</i>								
	No.	M ₁		M ₂			M ₃		
		L	B	No.	L	B	No.	L	
Males	153	11.1	12.5	151	10.1	12.5	120	9.2	11.9
Females	153	10.8	12.1	149	10.0	12.0	120	9.5	11.4
Males and females	306	10.9	12.3	300	10.0	12.3	240	9.3	11.7

	<i>Lower Jaw</i>								
	No.	M ₁		M ₂			M ₃		
		L	B	No.	L	B	No.	L	
Males	134	11.3	11.4	135	11.2	10.8	133	11.5	10.7
Females	146	7.6†	11.1	144	11.0	10.5	128	11.1	10.4
Males and females	280	9.7†	11.3	279	11.1	10.7	261	11.3	10.6

* Table extracted from Stein and Epstein (1934). Measurements on teeth in situ were made on a collection of New Britain skulls in the American Museum of Natural History. Skulls were sexed by Shapiro and Howells, but dentition was not included in criteria for sex classification. The authors note that mesodistal diameter (length) is frequently diminished by interproximal abrasion and occlusal wear beyond the contact points, but the widest labio-lingual diameter is rarely affected. Many average measurements are very close to those given for Ambrym by Dr. Dahlberg.

† So far from agreement with other comparable measurements that the figure is possibly a misprint.

RACIAL DIFFERENCES IN SIZE OF TEETH

Averages worked from combined measurements of the two sexes

Upper Jaw

Region	PM ₁		PM ₂		M ₁		M ₂		M ₃	
	L	B	L	B	L	B	L	B	L	B
Australian . . . (Campbell, 1925)	7.8	10.3	7.2	10.1	11.4	12.8	10.9	13.1	10.0	12.3
Melanesian . . . Ambrym (Dahlberg, 1942)	7.2	10.2	6.7	10.1	11.0	12.4	10.1	12.4	9.0	11.9
Negroes, S. Afr. Bantu . . . (Shaw, 1931)	7.2	9.0	7.0	9.1	10.3	11.0	10.0	11.5	9.5	11.0
Bushman (Drennan, 1929)	6.8	8.6	6.5	8.5	9.9	10.6	9.7	10.6	8.2	10.3
Modern White (Shaw, 1931)	7.2	9.1	6.8	8.8	10.7	11.3	9.2	11.5	8.6	10.6
Melanesian New Britain (Stein and Epstein, 1934)	10.9	12.3	10.0	12.3	9.3	11.7

Lower Jaw

Region	PM ₁		PM ₂		M ₁		M ₂		M ₃	
	L	B	L	B	L	B	L	B	L	B
Australian . . . (Campbell, 1925)	7.6	8.8	7.7	8.9	12.3	11.9	12.5	11.7	11.9	11.1
Melanesian Ambrym (Dahlberg, 1942)	11.6	10.8	11.0	10.6	11.5	10.5
Negroes, S. Afr. Bantu . . . (Shaw, 1931)	7.1	8.2	7.2	8.1	11.0	10.5	11.0	10.3	11.1	10.4
Bushman (Drennan, 1929)	6.9	7.6	7.0	7.8	10.9	10.2	10.6	10.1	9.9	9.6
Modern White (Shaw, 1931)	6.9	7.9	7.1	8.0	11.2	10.3	10.7	10.1	10.7	9.8
Melanesian New Britain (Stein and Epstein, 1934)	9.7*	11.3	11.1	10.7	11.3	10.6

Region	Total length M and PM		Total breadth M and PM		Excess length of lower teeth	Excess width of upper teeth
	Upper	Lower	Upper	Lower		
Australian (Campbell, 1925)	47.3	52.0	58.6	52.4	4.7	6.2
Melanesian, Ambrym (Dahlberg, 1942)	44.0	57.0
Negroes, S. Afr. Bantu (Shaw, 1931)	44.0	47.4	51.6	47.5	3.4	4.1
Bushman (Drennan, 1929)	41.1	45.3	48.6	45.3	4.2	3.3
Modern White (Shaw, 1931)	42.5	46.6	51.3	46.1	4.1	5.2

* So far from agreement with other comparable measurements that the figure is possibly a misprint.



APPENDIX 3: INTER-RACIAL STANDARD DEVIATIONS
FOR CRANIAL MEASUREMENTS

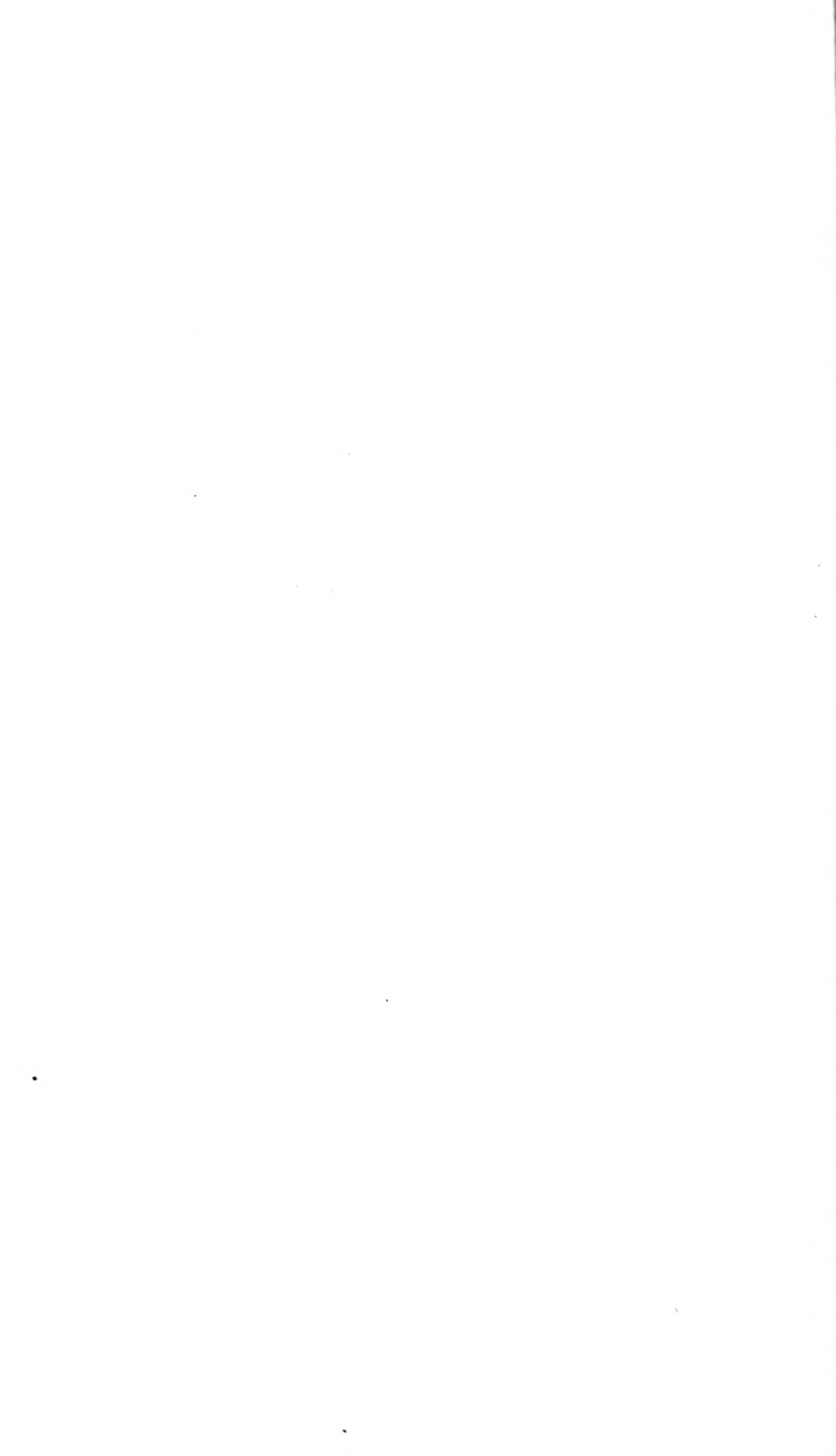

INTER-RACIAL STANDARD DEVIATIONS FOR CRANIAL MEASUREMENTS

For many years the desirability of working out standard deviations for series of measurements has been recognized by statisticians. The standard deviation, from which the standard error (and probable error) of an average is calculated, is a measure of the scatter, or conversely of the clustering, of the terms of a series; it is a measure of homogeneity and of heterogeneity. A high value of the standard deviation indicates a wide range of values for the individual terms of the series. In presenting these new tables I do so with all deference to the material published by Pearson and others for calculating standard deviations. But I believe that my revised tables are fully justified by the inclusion of many recent and valuable series of cranial standard deviations not previously collated.

So familiar have standard deviations for cranial traits become, that when checking over the statistical work of a student a teacher would immediately detect any marked aberration in the value of a standard deviation for any particular trait; for example, in running the eye down our collation of standard deviations for head length (p. 99) the value of 7.13 ± 0.57 is noted at once as being high for that measurement. The reason is not far to seek, since this standard deviation expresses the high variability of head length of a series of deformed skulls from Malekula. Frontal pressure during infancy is exerted to varying degrees for different children, so there is a corresponding uncertainty with regard to the elongation of the head that will be produced. But, despite a few exceptional values of the standard deviation, one soon becomes familiar with values that are normal, and these appear to be and actually are within a small range for each trait, for people of widely different appearance.

A student will realize, of course, that the standard deviation must bear a ratio to the average value of the series of terms whose scatter it expresses; thus, when we consider cranial capacities measured in cubic centimeters, we may have an average value of 1,240 cc., with a standard deviation of 100. For the average breadth of the nasal aperture (say 25 mm.) the standard deviation might well be valued at 2.0 to 3.0; hence there is no legitimate comparison

of absolute standard deviations for the different traits of the skull. One can say that standard deviations are large, normal, or small only with reference to some particular trait.

We have already considered the variability of skull traits in relation to sex; such variability is judged either by standard deviations, or by coefficients of variation that are derived from them by a simple formula (this work, p. 36). For three racial samples considered we concluded that, although the standard deviations and coefficients of variation are much the same in value, trait by trait, for the sexes, the males usually have a preponderance of the higher coefficients (this work, p. 39).

Pearson and Davin (1924) presented a series of standard deviations for a large series of Egyptian skulls, male and female, and my tables (pp. 99-102) quote these as well as a series of standard deviations for 124 male and 70 female skulls of New Guinea. We need not go to the length of comparing these standard deviations, trait by trait, for males and females, for each of the racial series, according to the usual biometric method for testing whether the differences are significant or not. Visual inspection informs us that the standard deviations for males and for females, trait by trait, show close correspondence in value. But the separation of the sexes for computation of average measurements requires that we shall also use two separate series of standard deviations, male and female, for the computation of the probable errors of the respective sex averages.

The nature of and the method of calculating the standard deviation is simply explained by G. Udny Yule (1937, p. 134).

$$\text{Standard deviation } (\sigma) = \sqrt{\frac{S(d^2)}{N}}$$

where S is the sum of the squares of the differences of each term of the series from the mean of the series, and N is the number of terms in the series.

$$\text{The standard error of SD} = \sqrt{\frac{\sigma}{2N}}$$

and this multiplied by the factor 0.674489 gives the probable error of the standard deviation.

When consulting the tables a student may have one or more objects in view; for example, he may have worked out for himself a series of standard deviations for his own measurements on a racial

series, and he wishes to check quickly the probable accuracy of his results instead of repeating his arithmetic. Furthermore, it frequently happens that a craniometrist will quote a useful series of average measurements for which he gives the number of measurements taken, but he does not publish individual measurements, standard deviations, or probable errors of the averages.

In such instances a choice of standard deviations must be made from the tables with due regard to race, size of sample, dependence on pooling, deformation, and reliability of technique.

One would naturally choose the standard deviations of a racial series which has satisfactory morphological correspondence with the series on which measurements have been made; thus, if a student has recorded measurements and worked out averages for skull traits of a Melanesian series he will for preference select the standard deviations for 124 males or 70 females of New Guinea, since these are the most suitable in our table with respect to both size and race. The probable errors of the averages for his series are then easily worked out, since the probable error of a mean is standard deviation divided by square root of the number of terms, and multiplied by 0.674489. The formula is

$$\frac{\sigma}{\sqrt{N}} \times 0.674489.$$

This acceptance of the standard deviations of an appropriate series saves an enormous amount of time. The question of accuracy which may be sacrificed by accepting the standard deviations of another series is a point which we will discuss later.

The validity of standard deviations naturally depends on the size of the series, for the greater the number of skulls, the more valid we may expect the standard deviation to be as a measure of the homogeneity or otherwise of the total population of which our series is only a small random sample. In this connection students should read Howells (1936), Tildesley (1940a, 1940b), and Morant (1939a). Morant shows very clearly in diagrammatic form how a curve of frequency distribution is smoothed out, and one definite mode is given by progressively increasing the size of a sample. Howells offers the opinion that a group of 50 measurements is the smallest for which sigmas (standard deviations) could be accepted as a criterion of group variability. Tildesley prepared tables to show arithmetically the changes in sigma value with the number in the sample.

Some of my standard deviations for small series were worked out (table, Nos. 8, 28-30) before the articles quoted were published,

so the data have been allowed to remain in the table, and by comparison of larger and smaller samples for the same race a student must judge for himself the hazards attendant on calculating standard deviations from small samples.

Obviously small samples may give standard deviations which might be unreliable for the whole population. In a small sample, even a few extreme values of measurements, whether low or high, greatly affect the standard deviation, and other points have to be considered. For example, a collector has obtained a small group of ancestral skulls from a dwelling house where such relics are preserved from generation to generation, and in all probability such a collection will be homogeneous; then the standard deviations will tend to be low. On the contrary, a small collection of skulls representing head-hunting trophies, taken from villages far and wide, may have unduly high variability and consequently high standard deviations, because the skulls are representative of many different tribes.

If we accept Howells' statement respecting the reliability of standard deviations, then for most of our cranial collections we must give only crude averages. Unfortunately, a craniometrist often has to regard 50 adult male skulls of one ethnic group, and from a reasonably small area, as a craniometrical prize. My own reaction is that in giving standard deviations for small series we do no more than say with diffidence that the standard deviations represent the best we can do with the limited evidence, and we hope that the series will some day be supplemented. Rightly or wrongly, therefore, we will retain the standard deviations of our small groups if only to show discrepancies between these and the corresponding data for larger series of the same race.

The question of high variability resulting from different degrees of cranial deformation has been mentioned previously (p. 89), and one should also look with suspicion on the validity of standard deviations derived from pooled figures. The data of Kitson (table, pp. 103-106, Nos. 18, 20) indicate that standard deviations are somewhat high because of the pooling of figures for Bushmen and for South African Kaffirs, respectively.

Finally, standard deviations for any trait of a series may be affected in size by the reliability of the technique for measuring that trait. The standard deviations for NH', height of nose from nasion to nasal spine, seem to illustrate this point since they have a considerable range of values. Nasal spine may be worn or broken, and in such instances some estimation of the point of measurement

is necessary. From this it follows that high variability of measurements may ensue. On the contrary, the more clearly defined the points of measurement, the more accurate and consistent the recorded measurements are likely to be.

In a previous paragraph (p. 91) mention was made of the possible adoption of standard deviations that might be used instead of working out a new series for some particular group. What kinds of errors are involved in such a time-saving device?

When working out the probable errors of averages of 59 cranial traits for a series of 124 males and 70 females of New Guinea, Hambly (1940) assumed the usefulness of Pearson and Davin's (1924) standard deviations of a long series of Egyptian skulls. Since the publication *Craniometry of New Guinea* was issued, the standard deviations have been worked out from the individual measurements for the series, and a new set of probable errors of the averages has been calculated. The results of comparing these probable errors with those afforded by use of standard deviations of the Egyptian series, which craniometrists have frequently used as a substitute, is as follows:

Out of 59 probable errors of averages for the male series, calculated by the two methods, 36 of the resulting differences are 0.03 or less; 18 differences are 0.01 or less, and 53 out of the 59 pairs of probable errors differ only in the second place of decimals. We therefore have to conclude that the sacrifice of accuracy in this instance was very small, and by accepting Pearson's standard deviations much time was saved.

For the female series of New Guinea the probable errors of the averages when worked out in the same way, first by using Pearson's Egyptian standard deviations, then by calculating the standard deviations for the New Guinea series, were as follows: For 57 traits out of 59 the probable errors are affected only in the second place of decimals, and one might reasonably expect such a result from noting the close approximation in value of standard deviations for corresponding traits of the Egyptian and New Guinea series (table, Nos. 1, 11).

Our final test of differences in probable errors of averages resulting from use of Egyptian standard deviations instead of those actually worked out for the series, involved a total of 246 probable errors of averages for a large number of traits for Melanesian skulls. This racial sample included skulls of New Guinea, New Britain, Solomon Islands, and many other regions.

For 79 out of 246 traits tested, the probable errors arrived at by the two methods differed by a value of 0.0 to 0.1; 44 probable errors differed by a value of 0.02 to 0.03, and the general conclusion seemed to be that the standard deviations of the Egyptian series would make a reliable and time-saving substitute for the actual standard deviations of any Melanesian series of reasonable length.

The acceptance or rejection of approximations is not altogether a matter of statistical validity—a personal element enters into the choice, just as it does in splitting the millimeter, in using square roots to a given number of decimal places, or giving a cranial index with either a first place or a second place of decimals. One has to balance saving of time against not unreasonable sacrifice of accuracy.

A comparison of various racial values for standard deviations leads to several possible exercises for testing their similarities and divergences for any particular trait.

(1) For comparison of two standard deviations see von Bonin (1936, p. 131) where he uses

$$M_1 - M_2 > 3 \sqrt{(PE_1)^2 + (PE_2)^2}$$

to test the significance of the difference between some standard deviations worked out for skulls of New Britain and those for corresponding traits of Pearson and Davin's Egyptian "E" series (1924). One should note that a difference in the standard deviations which is "significant" in a statistical sense does not necessarily mean that the standard deviation in question could not be used as a substitute. Such use might lead to only a slight difference, say in the second place of decimals, in the resulting probable error of the average; but there would be a hazard of accuracy in using such a standard deviation.

(2) A mean racial standard deviation for any trait can be calculated so as to give a weighted average for either an inter-racial group (all races) or an intra-racial group (e.g., Melanesians). In the tables (pp. 99–124) some data are insufficient for such calculation because craniometrists avoid taking certain measurements. Comparatively few workers give the arcs and chords S_1-S_3 , and $S_1'-S_3'$, but all measure length, breadth, height, and many other traits. Hence the columns for such measurements supply enough standard deviations for the calculation of a reliable mean racial standard deviation.

In calculating such a standard deviation we shall follow a formula used and explained by Morant (1935) in his study of the comparative variability of several bodily measurements of different European and Asiatic peoples.

To calculate the mean racial standard deviation for head lengths, for example, we square each of the 46 standard deviations (table, No. 47, pp. 115–118). The mean square is found by dividing the sum of the squares by 46, and the square root of this number is the mean racial standard deviation. The standard error of this mean inter-racial standard deviation is given by dividing it by the square root of 46. If our racial standard deviations are $SD_1, SD_2, SD_3 \dots SD_{46}$, and N is the number of racial standard deviations, then the mean inter-racial standard deviation is

$$\sqrt{\frac{SD_1^2 + SD_2^2 + \dots + SD_{46}^2}{N}}$$

The tables of standard deviations given in this appendix show such close approximation for corresponding skull traits of different races that they are in harmony with Morant's observation (1935) that stature and other bodily traits of groups of people in different parts of the world exhibit variabilities that are remarkably similar to one another.

(3) Howells (1936) makes a suggestion for testing the probable validity of any standard deviation, or series of standard deviations, by comparing them individually with the mean inter-racial standard deviations for the traits in question. Let us suppose that the mean inter-racial standard deviation for head lengths is 5.97 ± 0.10 ; then as we glance down the column we note that whereas most standard deviations approximate closely to this mean others are aberrant. We ask ourselves which are acceptable and which should be regarded as abnormal, perhaps because of inaccurate arithmetic, pooling of material, faulty technique in measurement, or deformation of the skull. Howells suggests taking around this mean a zone equal to \pm three times the standard deviation of the mean (5.97). The zone would be 2.97 to 8.97, which would include each of the 46 standard deviations for head length (table, pp. 99–118). But the standard deviations for Hawaiian skulls (small sample), for Malekula skulls (deformed), and for Pecos skulls (deformed) come near the upper limit; so close in fact that their validity would be suspected. There are in the table no standard deviations for head lengths that come at all near the lower limit of normalcy.

This zoning, and finding whether certain values fall within a zone of probable accuracy, are of course a crude method. Let us see by another method what our conclusion would be if we suspected a standard deviation of 7.13 (deformed skulls, Malekula) of being aberrant and unacceptable. Since the mean inter-racial standard

deviation is about 5.97 ± 0.10 and our dubious deviation is 7.13 ± 0.57 we are testing a difference of $7.13 - 5.97 = 1.16$. The square root of the sum of the squares of both probable errors is

$$\sqrt{0.10^2 + 0.57^2} = 0.5787$$

and the ΔP_{Δ} value is

$$1.16 / 0.5787 = 2.0.$$

Statistically speaking, the difference of the two standard deviations is not significant, for that difference is less than three times the square root of the sum of the squares of both probable errors. Our suspected standard deviation of 7.13 is not demonstrably an impostor, but the high upward variation from the mean justifies our suspicion of abnormality, and it is in fact a standard deviation which is aberrant for two reasons, namely, the small size of the sample and the deformation of the skulls.

In conclusion, one may hope that these tables, which represent much labor in arithmetic on one's own figures and also on the data of others, may prove a time-saving device for students. This should be so if the tables are intelligently used as a gauge or check so as to avoid repetition of arithmetic. Moreover, the tables should supply a number of standard deviations that may be adopted without seriously affecting the resulting probable errors of averages. One must, however, emphasize the need for careful selection, by size of sample, by race, and with the avoidance of samples whose standard deviations are likely to have been affected by cranial deformation, by racial mixture, or other cause.

If in difficulty in making a choice, a student will perhaps use the Egyptian "E" series of standard deviations, and in all probability, as judged by their application to New Guinea data, he will have no need to feel himself a statistical delinquent.

The inter-racial standard deviations are very close to those for the long Egyptian series, which is a predictable conclusion from all that has been written on biometric constants of the human skull.

Of exceptional interest is a test case of applying inter-racial standard deviations for finding the probable errors of average measurements of Howells' 120 Early Christian Irish skulls. To consider skull length as an example, Howells worked his own standard deviation, which is 6.05 ± 0.27 ; this is practically identical with the inter-racial standard deviation of 6.04 ± 0.10 . For the breadth of the Irish skulls the standard deviation is 4.94 ± 0.22 , which is very close to the inter-racial standard deviation of 4.92 ± 0.10 . Many inter-racial-Irish comparisons are as close or almost as close as these instances.

There seems to be no doubt about the usefulness of inter-racial standard deviations, or the standard deviations of any long series, as a substitute for the tedious working out of new series of standard deviations.

Standard deviations for small series, though not necessarily in conflict with those for a long series, must be viewed with suspicion, and the same caution applies to those for deformed skulls, "pooled" figures, and for measurements based on a technique which uses cranial points that are not well defined.

If a student prefers *never* to adopt standard deviations from another series, the tables given here will at least serve as a time-saving device in checking his arithmetic. If the arithmetic is correct, then the standard deviations obtained for any series of reasonable length should be very close to those for the Egyptian "E" series, and to those inter-racial standard deviations which I have calculated from a substantial amount of data.

IDENTIFICATION KEY TO TABLE OF RACIAL STANDARD DEVIATIONS: MALE SKULLS

1. Egyptian "E" series, 935 skulls; Pearson, K., and Davin, A. G. (1924).
2. Hythe series, 112 skulls; Stoessiger, B. N., and Morant, G. M. (1932).
3. Kaniët Island, near New Guinea, 18 skulls; Hambruch, P. (1906).
4. New Britain, 229 skulls; von Bonin, G. (1936).
5. Australian "A" series, 146 skulls; Morant, G. M. (1927).
6. Tasmania, 62 skulls; Morant, G. M. (1927).
7. Maori, New Zealand, 40 skulls; Wagner, K. A. (1937).
8. Maori, New Zealand, 7 skulls; Hambly, W. D. (unpublished).
9. Hawaii, 17 skulls; Hambly, W. D. (unpublished).
10. Malekula, 35 skulls, deformed; Hambly, W. D. (unpublished).
11. New Guinea, 124 skulls; Hambly, W. D. (1940).
12. WaTeita Tribe, East Africa, 40 or more skulls; Kitson, E. (1931).
13. Congo, 30 or more skulls; Kitson, E. (1931) quoting Crewdson-Benington, R.
14. Cameroons, 30 or more skulls; Kitson, E. (1931) quoting Drontschilow, K.
15. Gaboon, 30 or more skulls; Kitson, E. (1931) quoting Crewdson-Benington, R.
16. Negroes from Egypt, 30 or more skulls; Kitson, E. (1931) quoting Schmidt, E.
17. Tanganyika Territory, 30 or more skulls; Kitson, E. (1931) quoting Ried, H. A.
18. Bushmen pooled, 30 or more skulls; Kitson, E. (1931).
19. Galla and Somali, pooled, 30 or more skulls; Kitson, E. (1931).
20. Kaffirs, pooled, 30 or more skulls; Kitson, E. (1931).
21. Lachish, Palestine, 327 skulls; Risdon, D. L. (1939).
22. Iran, Hissar III, 51 skulls; Krogman, W. M. (1940).
23. Iran, Hissar III, 39 skulls; Krogman, W. M. (1940).
24. Pecos Pueblo, 126 skulls; Hooton, E. A., Total "A" series (1930).
25. Pecos Pueblo, 95 skulls (deformed); Hooton, E. A., Total "A" series (1930).

26. Pecos Pueblo, 50 skulls, undeformed; Hooton, E. A., Total "A" series (1930).
27. North China, 86 skulls; Black, D. (1928).
28. Solomon Islands, 6 skulls; Hambly, W. D. (unpublished).
29. New Caledonia, 13 skulls; Hambly, W. D. (unpublished).
30. New Ireland, 13 skulls; Hambly, W. D. (unpublished).
31. Ambrym, New Hebrides, 20 skulls; Hambly, W. D. (this work).
32. Australia, 103 skulls; Wagner, K. A. (1937).
33. North American Indians, northern California, 54 skulls; von Bonin, G. (1938).
34. Indians, central California, 45 skulls; von Bonin, G. (1938).
35. San Francisco Bay and vicinity, Indians, 146 skulls; von Bonin, G. (1938).
36. Indians, Santa Barbara County, 51 skulls; von Bonin, G. (1938).
37. Indians, Santa Cruz and Santa Rosa Islands, 199 skulls; von Bonin, G. (1938).
38. Indians, Santa Catalina, San Clemente, San Nicolas Islands, 41 skulls; von Bonin, G. (1938).
39. Indians, northeastern Algonkin, 120 skulls; von Bonin, G. (1938).
40. East central Algonkin, 94 skulls; von Bonin, G. (1938).
41. Indians, western Algonkin, 49 skulls; von Bonin, G. (1938).
42. Indians, Sioux, 61 skulls; von Bonin, G. (1938).
43. Indians, Arikara, 53 skulls; von Bonin, G. (1938).
44. Indians, Florida, 121 skulls; von Bonin, G. (1938).
45. Old Irish, 120 skulls; Howells, W. W. (1941).
46. Scottish, 524 skulls; Young, M. (1931).
47. Inter-racial standard deviations.
48. Difference in probable errors of means, using standard deviations of No. 45 (Howells' Early Irish) or the inter-racial standard deviations (47).

Figures in brackets above an average measurement indicate the number of skulls measured for that particular trait. If no figure is quoted above the average measurement, the reader must assume that the full number of skulls (see key) was measured for that trait.

For details of works of authors quoted see Bibliography.

IDENTIFICATION KEY TO TABLE OF RACIAL STANDARD DEVIATIONS: FEMALE SKULLS

1. Ambrym, New Hebrides, 11 skulls; W. D. Hambly (this work).
2. Egyptian "E" series, 628 skulls; Pearson, K., and Davin, A. G. (1924).
3. Hythe series, England, 87 skulls; Stoessiger, B. N., and Morant, G. M. (1932).
4. Australian "A" series, 75 skulls; Morant, G. M. (1927).
5. Southwest New Guinea, 13 skulls; Graf, L. A. (1931).
6. Malekula, New Hebrides, 21 skulls, deformed; Hambly, W. D. (unpublished).
7. New Guinea, 70 skulls; Hambly, W. D. (1940).
8. Maori, New Zealand, 26 skulls; Wagner, K. A. (1937).
9. WaTeita, East Africa, 40 skulls; Kitson, E. (1931).
10. Lachish, Palestine, 261 skulls; Risdon, D. L. (1939).
11. Iran, Hissar III, 32 skulls; Krogman, W. M. (1940).
12. Pecos, Total "A" series, 95 skulls; Hooton, E. A. (1930).
13. Pecos, Total "A" series, 71 skulls, deformed; Hooton, E. A. (1930).
14. Pecos, Total "A" series, 26 skulls, undeformed; Hooton, E. A. (1930).
15. Scottish, 373 skulls; Young, M. (1931).

STANDARD DEVIATIONS: MALES

Numbers 1-11

Key number	Capacity in cc.	L	B	B'	H'	LB	Si	Si'	Se	Se'	S ₃	S ₃ '	S	GLU	U
1	(753) 113.51 ±1.97	(895) 5.72 ±0.09	(896) 4.76 ±0.08	(109) 4.05 ±0.06	(884) 5.03 ±0.08	(896) 3.97 ±0.06	(928) 6.22 ±0.10		(908) 7.42 ±0.12		(889) 6.81 ±0.11	(885) 4.81 ±0.08	(884) 12.51 ±0.20		(876) 13.77 ±0.22
2	(110) 109.70 ±5.00	6.16 ±0.28	5.35 ±0.24	4.77 ±0.22	4.99 ±0.22	3.58 ±0.16	5.79 ±0.26	4.21 ±0.19	6.87 ±0.31	5.77 ±0.26	7.55 ±0.34	5.00 ±0.23	15.03 ±0.68		15.28 ±0.69
3	72.40 ±8.14	5.74 ±0.64	4.31 ±0.48	2.72 ±0.30	5.23 ±0.58	3.81 ±0.43	5.17 ±0.58	3.36 ±0.38	7.43 ±0.83	5.72 ±0.66	5.50 ±0.62	7.45 ±0.86	10.00 ±1.12	12.16 ±1.49	
4		5.70 ±0.18	4.36 ±0.14	4.85 ±0.15	4.41 ±0.14	3.99 ±0.13							11.80 ±0.38		13.82 ±0.44
5	120.00 ±4.7	(82) 6.67 ±0.35	(162) 4.95 ±0.19	(138) 5.36 ±0.22	(144) 4.94 ±0.20	(137) 4.34 ±0.18	(77) 6.81 ±0.37		(75) 7.43 ±0.41		(72) 6.17 ±0.35		13.62 ±0.67		16.50 ±0.67
6			5.32 ±0.33	4.81 ±0.29	4.76 ±0.31	4.13 ±0.27									
7	(35) 100.00 ±8.05	5.43* ±0.40	4.43 ±0.32	4.94 ±0.36	4.99 ±0.38	3.72 ±0.28	7.63 ±0.57	5.04 ±0.38	6.84 ±0.52	5.77 ±0.44	6.69 ±0.50	4.51 ±0.34	14.01 ±1.06	10.80 ±0.81	11.35 ±0.86
8	84.39 ±15.21	4.37 ±0.79	5.55 ±1.00	5.68 ±1.02	2.55 ±0.46	4.55 ±0.82	5.92 ±1.07	4.30 ±0.77	4.12 ±0.74	3.20 ±0.58	4.69 ±0.74	3.34 ±0.60	7.57 ±1.36	7.40 ±1.33	6.74 ±1.21
9	(16) 102.2 ±12.18	8.42 ±0.97	3.77 ±0.44	3.86 ±0.45	3.53 ±0.41	3.79 ±0.45	5.65 ±0.65	4.06 ±0.47	6.90 ±0.80	5.35 ±0.61	6.62 ±0.76	3.85 ±0.44	13.71 ±1.58	16.08 ±1.86	14.50 ±1.68
10	(33) 79.65 ±6.61	7.13 ±0.57	5.18 ±0.42	4.71 ±0.38	4.09 ±0.33	4.21 ±0.34	5.78 ±0.46	5.67 ±0.46	7.37 ±0.59	5.83 ±0.47	7.59 ±0.61	6.51 ±0.53	12.37 ±1.00	13.45 ±1.08	14.70 ±1.13
11	100.00 ±4.28	6.88 ±0.30	5.22 ±0.22	4.38 ±0.19	4.04 ±0.19	3.64 ±0.17	6.20 ±0.27	4.31 ±0.19	7.95 ±0.34	6.23 ±0.27	7.33 ±0.34	4.94 ±0.23	13.23 ±0.61	14.76 ±0.63	14.70 ±0.63

STANDARD DEVIATIONS: MALES

Numbers 1-11—Continued

Key number	BQ'	GB	J	G'H	GL	NHR	NHL	NH'	NB	O ₁ R	O ₂ R	O ₃ L	O ₂ L	O ₁ R	O ₁ L
1	(877) 4.67 ±0.08	(785) 4.57 ±0.08	(845) 4.15 ±0.07	(832) 4.85 ±0.08	(898) 2.92 ±0.05	(893) 1.77 ±0.03	(886) 1.67 ±0.03	(888) 1.91 ±0.03	(880) 1.65 ±0.03	(888) 1.88 ±0.03
2	10.49 ±0.47 10.00 ±1.12	(99) 5.17 ±0.25	(96) 5.12 ±0.25	(89) 3.84 ±0.19	(89) 4.83 ±0.24	(111) 2.94 ±0.13	2.85 ±0.13	3.24 ±0.16	(108) 1.66 ±0.08	(111) 1.56 ±0.07	(111) 1.90 ±0.09	(109) 1.56 ±0.07	(110) 1.81 ±0.08	(82) 1.51 ±0.08	(109) 1.56 ±0.07
3	(219)* 4.28 ±0.14	(203) 5.02 ±0.17	(217) 3.96 ±0.13	(215) 4.46 ±0.20
4
5	(139) 6.07 ±0.25	(79) 4.21 ±0.23	(106) 5.88 ±0.27	(118) 3.14 ±0.14	(120) 2.00 ±0.07
6	(50) 5.40 ±0.36	(58) 3.47 ±0.22	(57) 1.69 ±0.11
7	7.89 ±0.59	(33) 5.56 ±0.46	2.93 ±0.21	3.08 ±0.23	(39) 1.76 ±0.13
8	4.69 ±0.84	4.53 ±0.82	3.89 ±0.70	2.89 ±0.52	6.71 ±1.21	1.93 ±0.35	1.50 ±0.27	1.61 ±0.29	2.19 ±0.39	0.69 ±0.12	2.21 ±0.40	1.36 ±0.24	1.80 ±0.32	2.83 ±0.51	1.56 ±0.28
9	5.46 ±0.63	3.67 ±0.44	4.42 ±0.53	2.60 ±0.39	7.16 ±0.88	3.25 ±0.40	2.94 ±0.35	3.04 ±0.36	0.47 ±0.05	1.17 ±0.14	1.61 ±0.18	1.00 ±0.12	1.30 ±0.15	1.22 ±0.15	0.61 ±0.08
10	9.66 ±0.77	3.50 ±0.32	3.21 ±0.29	5.64 ±0.46	4.48 ±0.38	2.86 ±0.24	3.10 ±0.26	3.89 ±0.33	2.41 ±0.19	1.30 ±0.11	2.01 ±0.17	1.39 ±0.11	2.43 ±0.20	1.57 ±0.22	1.65 ±0.23
11	9.21 ±0.39	4.60 ±0.19	5.06 ±0.22	4.45 ±0.19	4.94 ±0.23	3.44 ±0.15	3.12 ±0.13	2.95 ±0.13	1.67 ±0.07	1.72 ±0.07	1.80 ±0.07	1.67 ±0.07	1.78 ±0.07	1.56 ±0.09	1.78 ±0.11

STANDARD DEVIATIONS: MALES
Numbers 1-11—Continued

Key number	Lac O ₁ L	Lac O ₂ L	DC	G ₁	G ₂	G ₁ '	EH	fml	fmb	100B L	100H' L	100B H'	100(B-H') L	Ocl	100G'H GB	
1	(817) 3.33 ±0.06	(703) 2.63 ±0.05	(821) 3.10 ±0.05	(905) 2.47 ±0.04	(894) 2.15 ±0.03	(884) 2.68 ±0.06	(871) 2.94 ±0.05	(884) 4.30 ±0.06	(884) 3.30 ±0.05	(823) 4.96 ±0.08	
2	(73) 1.44 ±0.08	(109) 2.16 ±0.10	(96) 3.14 ±0.10	(51) 2.72 ±0.20	(98) 2.81 ±0.20	(47) 2.81 ±0.20	(111) 2.17 ±0.11	(110) 2.53 ±0.25	(80)
3
4	(105) 3.09 ±0.14	(196) 2.93 ±0.10	(223) 2.28 ±0.07	(223) 1.93 ±0.06	(226) 2.66 ±0.08	(226) 3.95 ±0.12	(226) 2.85 ±0.09	(228) 2.28 ±0.08	(209) 4.48 ±0.15
5	(86) 2.06 ±0.11	(54) 3.93 ±0.26	(28) 2.93 ±0.19	(130) 2.52 ±0.11	(111) 2.17 ±0.10	(94) 3.88 ±0.19	(91) 3.70 ±0.21	(156) 5.41 ±0.21
6	(53) 2.82 ±0.18	(55) 4.05 ±0.26
7	(37) 2.01 ±0.15	(34) 2.95 ±0.24	(34) 2.76 ±0.23	(39) 2.27 ±0.17	(39) 2.05 ±0.15
8	0.87 ±0.16	1.64 ±0.30	3.00 ±0.54	2.35 ±0.42	3.40 ±0.61	1.24 ±0.22	2.51 ±0.45	1.49 ±0.27	4.16 ±0.75	2.34 ±0.42	3.59 ±0.65	2.53 ±0.45	3.16 ±0.57	3.22 ±0.58
9	(15) 1.22 ±0.15	1.50 ±0.17	(15) 2.54 ±0.31	(16) 3.71 ±0.44	(15) 2.75 ±0.37	(14) 1.43 ±0.18	(16) 1.67 ±0.20	1.94 ±0.22	4.84 ±0.56	2.86 ±0.34	(16) 3.04 ±0.36	(16) 2.31 ±0.27	4.37 ±0.51	4.65 ±0.55	(16)
10	(12) 1.39 ±0.19	(34) 1.52 ±0.21	(25) 2.79 ±0.26	(30) 3.37 ±0.43	(30) 3.14 ±0.30	(25) 1.97 ±0.19	(34) 2.28 ±0.19	(31) 2.20 ±0.19
11	(60) 1.66 ±0.10	(59) 1.78 ±0.11	(96) 4.10 ±0.19	(123) 3.39 ±0.15	(102) 3.66 ±0.17	(100) 2.21 ±0.11	(104) 2.38 ±0.11	(104) 2.11 ±0.10

STANDARD DEVIATIONS: MALES
Numbers 1-11 — *Concluded*

Key number	100NB NHR	100NB NH'	100O ₂ R O ₂ R	100O ₂ R LacOR	100G ₂ G ₁	100EH G ₂	100fmb fml	A Z	B Z	N Z	P Z	Pros. P.Z.	Weight in grms.
1	(881) 3.82 ±0.06	(878) 5.05 ±0.08	(81) 5.34 ±0.23	(73) 5.34 ±0.30	(668) 6.79 ±0.13	(48) 8.07 ±0.56	(889) 5.79 ±0.09	(818) 3.46 ±0.06	(818) 2.66 ±0.04	(818) 3.31 ±0.06	(795) 3.24 ±0.05	(88)	
2	(107) 3.67 ±0.17	(95) 4.07 ±0.20	(81) 5.34 ±0.28	(73) 5.34 ±0.30	(46) 6.96 ±0.49	(47) 6.53 ±0.45	(110) 5.56 ±0.25	(89) 2.51 ±0.13	(89) 2.40 ±0.12	(89) 3.04 ±0.15	(88) 3.38 ±0.17	(88) 3.50 ±0.18	
3							6.36 ±0.61						
4		(126) 4.76 ±0.20			(91) 5.75 ±0.29		(223) 5.82 ±0.19						
5		(132) 5.71 ±0.21			(54) 6.98 ±0.45		(112) 5.83 ±0.26						
6		(57) 4.75 ±0.30											
7		(39) 4.11 ±0.30			(31) 6.22 ±0.53		(39) 5.87 ±0.44	(36) 3.27 ±0.26	(36) 2.79 ±0.22	(34) 3.95 ±0.31	(34) 3.02 ±0.25		
8				(4) 7.66 ±1.83	4.18 ±0.81	2.50 ±0.45	7.84 ±1.41	4.94 ±0.89	2.36 ±0.42	4.74 ±0.85	4.94 ±0.89	5.61 ±1.01	77.0 ±13.87
9				(15) 4.27 ±0.52	(15) 3.54 ±0.42	(14) 2.62 ±0.33	(16) 4.98 ±0.59	(15) 2.54 ±0.31	(15) 1.43 ±0.18	(15) 3.06 ±0.38	(16) 2.81 ±0.33	(16) 3.02 ±0.36	(16) 77.94 ±9.29
10				(33) 4.63 ±0.38	(32) 5.45 ±0.42	(25) 5.66 ±0.54	(31) 5.50 ±0.47	(32) 3.54 ±0.30	(32) 2.99 ±0.25	(32) 3.89 ±0.33	(33) 4.02 ±0.33	(33) 3.68 ±0.30	(33) 105.70 ±8.77
11				(123) 4.17 ±0.17	(96) 5.62 ±0.19	(102) 8.05 ±0.38	(100) 5.68 ±0.24	(104) 3.38 ±0.15	(104) 2.40 ±0.11	(104) 3.50 ±0.16	(112) 4.25 ±0.19	(112) 4.12 ±0.18	

STANDARD DEVIATIONS: MALES
Numbers 12-22

Key number	Capacity in cc.	L	B	B'	H'	LB	S ₁	S ₁ '	S ₂	S ₂ '	S ₃	S ₃ '	S	GLU	U
12	6.07	4.33	4.50	4.47	4.24	5.30	8.79	7.88	13.85	13.51
	±0.40	±0.28	±0.29	±0.32	±0.21	±0.35	±0.57	±0.57	±1.02	±0.88
13	7.05	5.00	4.13	17.24
	±0.49	±0.34	±0.28	±1.16
14	5.88	4.76	4.35	13.82
	±0.30	±0.25	±0.23	±0.71
15	5.61	3.38	5.02	11.44
	±0.28	±0.23	±0.34	±0.77
16	5.66	5.93	3.83	10.01
	±0.46	±0.48	±0.31	±0.81
17	5.63	4.70	4.03	15.60
	±0.44	±0.36	±0.31	±1.21
18	5.64	4.85	4.06
	±0.36	±0.31	±0.28
19	6.75	6.35
	±0.53	±0.51
20	7.12	5.08	4.55	14.06
	±0.44	±0.32	±0.29	±0.92
	(322)	(319)	(268)	(296)	(299)	(321)	(323)	(299)	(280)	(255)	(304)
21	5.88	5.10	4.26	5.00	3.82	6.01	4.51	7.25	5.88	6.98	4.73	12.73	13.51
	±0.16	±0.13	±0.11	±0.15	±0.12	±0.17	±0.12	±0.19	±0.16	±0.20	±0.13	±0.38	±0.37
	(42)	(42)	(49)	(49)	(50)
22	8.01	4.55	3.86	4.34	3.52	6.11	6.45	6.94	8.14	12.67
	±0.53	±0.30	±0.26	±0.32	±0.26	±0.41	±0.43	±0.47	±0.55	±0.85

STANDARD DEVIATIONS: MALES
 Numbers 12-22—Continued

Key number	BQ'	GB	J	G'H	GL	NHR	NHL	NH'	NB	O ₁ R	O ₂ R	O ₁ L	O ₂ L	O ₁ 'R	O ₁ 'L
12	8.56 ±0.59						3.08 ±0.21		1.79 ±0.12			1.64 ±0.11	1.97 ±0.14		
13				4.14 ±0.28							2.19 ±0.15				
14				4.45 ±0.23							1.90 ±0.10				
15				6.01 ±0.41							2.09 ±0.14				
16				3.84 ±0.32							2.20 ±0.18				
17				4.79 ±0.38							2.16 ±0.16				
18				4.84 ±0.36							2.03 ±0.14				
19											2.77 ±1.24				
20				4.92 ±0.31							2.25 ±0.14				
21	(306) 9.60 ±0.26	(107) 4.81 ±0.22	(49) 4.97 ±0.34	(98) 4.36 ±0.21	(89) 4.71 ±0.24		(136) 2.64 ±0.11		(123) 1.74 ±0.07			(148) 1.64 ±0.06	(152) 2.05 ±0.08		
22	(49) 9.70 ±0.66	(45) 3.26 ±0.23	(43) 4.44 ±0.32	(49) 4.83 ±0.33	(48) 2.99 ±0.21		(48) 2.89 ±0.20		(44) 1.59 ±0.11			(48) 1.73 ±0.12	(49) 1.87 ±0.13		(41) 1.66 ±0.12

STANDARD DEVIATIONS: MALES
 Numbers 12-22—Continued

Key number	Lac O ₁ R	Lac O ₁ L	DC	G ₁	G ₂	Gr'	EH	fml	fmb	$\frac{100B}{L}$	$\frac{100H'}{L}$	$\frac{100B}{H'}$	$\frac{100(B-H')}{L}$	OcI	$\frac{100G'H}{GB}$
12	2.47 ±0.18	1.68 ±0.13	3.01 ±0.20	2.53 ±0.18	4.50 ±0.32	2.10 ±0.15
13	2.58 ±0.17	2.88 ±0.20
14	3.04 ±0.16	3.08 ±0.16
15	2.77 ±0.19	2.43 ±0.16
16	4.49 ±0.36
17	2.21 ±0.18	2.60 ±0.20
18	3.42 ±0.22	2.20 ±0.15
19	3.77 ±0.30
20	3.70 ±0.23	2.53 ±0.16
21	(57)	(100)	(247)	(244)	(310)	(257)	(256)	(246)	(278)	(63)
	2.29	2.79	2.52	2.16	3.08	2.93	4.72	3.25	2.59	4.64
	±0.14	±0.13	±0.08	±0.07	±0.08	±0.08	±0.14	±0.10	±0.07	±0.28
22	(38)	(44)	(42)	(40)	(42)
	3.63	2.66	2.57	2.18	3.22	2.76	3.44
	±0.28	±0.19	±0.19	±0.16	±0.21	±0.20	±0.25

STANDARD DEVIATIONS: MALES
 Numbers 12-22—Concluded

Key number	100NB NHR	100NB NH'	100O ₂ R O ₁ R	100O ₂ R O ₁ R	100O ₂ R LacO ₁ R	100G ₂ G ₁	100G ₂ G ₁ '	100EH G ₂	100fmb fml	A Z	B Z	N Z	P Z	Pros. P.Z.	Weight in gms.
12.....	3.74 ±0.26	4.89 ±0.31
13.....	4.91 ±0.33
14.....	4.63 ±0.24
15.....	4.89 ±0.33
16.....	5.58 ±0.46
17.....
18.....	6.51 ±0.46
19.....
20.....	5.21 ±0.38
21.....	(114) 4.00 ±0.18	(141) 4.96 ±0.20	(44) 4.95 ±0.36	(222) 5.82 ±0.19	(89) 2.77 ±0.14	(89) 2.83 ±0.14	(89) 2.77 ±0.14	(89) 3.43 ±0.17	(81) 3.14 ±0.17
22.....	(44) 4.29 ±0.31	(48) 5.60 ±0.38	(43) 5.70 ±0.41	(39) 5.41 ±0.41	(49) 2.73 ±0.19

STANDARD DEVIATIONS: MALES
Numbers 23-32

Key number	Capacity in cc.	L	B	B'	H'	LB	S ₁	S ₁ '	S ₂	S ₂ '	S ₃	S ₃ '	S	GLU	U
23.....	4.92 ±0.38	4.06 ±0.31	4.26 ±0.33	6.05 ±0.47	(37) 3.90 4.48	(38) 4.48 ±0.35	6.80 ±0.52	7.38 ±0.56	9.38 ±0.72	11.78 ±0.90
24.....	3.67 ±0.18
25.....	(68) 100.15 ±5.78	8.46 ±0.41	(91) 6.13 ±0.31	(93) 4.83 ±0.24	(80) 5.23 ±0.28	(67) 3.55 ±0.21	(85) 12.50 ±0.65	(90) 14.90 ±0.75
26.....	(31) 118.09 ±10.11	8.15 ±0.58	(45) 6.14 ±0.44	(27) 6.27 ±0.42	(34) 6.49 ±0.53	(27) 3.78 ±0.35	(36) 16.25 ±1.29	(43) 14.80 ±1.08
27.....	6.50 ±0.30	4.60 ±0.24	(85) 4.40 ±0.25	5.70 ±0.29	4.40 ±0.23	(82) 14.00 ±0.74	(74) 14.70 ±0.82
28.....	80.47 ±15.67	5.08 ±0.99	2.91 ±0.57	5.87 ±1.14	3.24 ±0.63	3.49 ±0.68	4.61 ±0.90	3.45 ±0.67	7.78 ±1.51	6.50 ±1.27	4.06 ±0.79	3.53 ±0.69	12.57 ±2.45	14.14 ±2.75	13.19 ±2.57
29.....	67.55 ±8.94	6.48 ±0.86	5.49 ±0.73	3.48 ±0.46	3.65 ±0.48	4.91 ±0.65	6.14 ±0.81	4.59 ±0.61	9.83 ±1.30	8.96 ±1.19	5.46 ±0.72	4.29 ±0.57	10.12 ±1.33	11.66 ±1.54	10.72 ±1.42
30.....	119.00 ±15.74	5.63 ±0.74	7.65 ±1.01	6.14 ±0.81	5.94 ±0.78	4.51 ±0.59	5.58 ±0.73	4.26 ±0.56	9.74 ±1.29	7.07 ±0.94	7.57 ±1.04	3.15 ±0.43	9.31 ±1.28	17.57 ±2.32	14.47 ±1.91
31.....	102.50 ±10.93	6.93 ±0.93	4.09 ±0.44	3.41 ±0.36	4.85 ±0.52	4.88 ±0.52	5.27 ±0.56	4.20 ±0.44	9.45 ±1.00	7.91 ±0.84	6.43 ±0.69	3.48 ±0.37	14.05 ±1.50	15.63 ±1.66	16.44 ±1.75
32.....	(98) 101.80 ±4.90	5.89 ±0.28	4.76 ±0.21	4.84 ±0.23	4.99 ±0.23	4.29 ±0.19	7.03 ±0.32	4.76 ±0.21	6.61 ±0.30	5.55 ±0.26	5.60 ±0.26	39.4 ±0.19	12.64 ±0.59	15.51 ±0.73	14.95 ±0.69

STANDARD DEVIATIONS: MALES
Numbers 23-32—Continued

Key number	BQ	GB	J	G'H	GL	NHR	NHL	NH'	NB	O ₁ R	O ₂ R	O ₃ L	O ₄ L	O ₁ R	O ₂ L	O ₁ 'L	
23	(38) 8.30 ±0.64	5.42 ±0.41	(35) 6.01 ±0.48	5.86 ±0.45	(36) 2.83 ±0.22	(125) 2.74 ±0.12	3.69 ±0.28	(112) 3.95 ±0.18	0.97 ±0.07	(119) 1.82 ±0.08	(119) 1.61 ±0.07	1.55 (117) 1.89	1.81 ±0.14 1.60	(35) 2.10 ±0.17
24	6.17 ±0.29
25	(91) 12.80 ±0.64
26	(36) 12.22 ±0.97
27	(60) 11.60 ±0.72	(83) 4.30 ±0.22	(84) 4.10 ±0.21	2.90 ±0.15	1.70 ±0.09	3.00 ±0.18	(74) 1.80 ±0.10
28	7.82 ±1.52	6.52 ±1.27	4.78 ±0.93	4.33 ±0.84	3.56 ±0.69	3.35 ±0.65	2.84 ±0.55	1.60 ±0.54	2.22 ±0.43	1.81 ±0.35	1.13 ±0.22	1.30 ±0.25	1.04 ±0.20	1.76 ±0.69	1.04 ±0.20	1.87 ±0.73	(3) (8)
29	6.14 ±0.81	3.82 ±0.50	6.79 ±0.90	3.61 ±0.48	4.25 ±0.56	2.79 ±0.37	2.83 ±0.37	2.81 ±0.40	1.33 ±0.17	0.08 ±0.01	2.29 ±0.30	1.23 ±0.16	2.16 ±0.28	0.09 ±0.01	2.16 ±0.28	1.36 ±0.21	(3) (9)
30	12.82 ±1.70	5.93 ±0.85	6.80 ±0.98	5.92 ±0.85	4.06 ±0.58	4.51 ±0.65	4.21 ±0.61	4.10 ±0.59	2.09 ±0.30	1.90 ±0.27	1.89 ±0.27	2.23 ±0.32	2.12 ±0.30	2.22 ±0.35	2.12 ±0.30	2.31 ±0.36	(9) (19)
31	9.69 ±1.03	3.07 ±0.32	3.29 ±0.37	3.15 ±0.34	3.77 ±0.41	3.18 ±0.34	2.63 ±0.28	2.84 ±0.30	1.77 ±0.19	1.69 ±0.18	1.97 ±0.21	1.69 ±0.18	2.38 ±0.26	1.14 ±0.12	1.14 ±0.12	1.36 ±0.14
32	9.90 ±0.46	4.84 ±0.23	5.61 ±2.8	3.98 ±0.19	5.62 ±0.27	3.47 ±0.15	2.98 ±0.13	2.03 ±0.09	2.01 ±0.09	2.29 ±0.11

STANDARD DEVIATIONS: MALES
Numbers 23-32—Continued

Key number	Lac O:R	Lac O:L	DC	G ₁	G ₂	G ₁ '	EH	fml	fmb	$\frac{100B}{L}$	$\frac{100H'}{L}$	$\frac{100B}{H'}$	$\frac{100(B-H')}{L}$	OcI	$\frac{100GH}{GB}$	
23.....	(35) 4.22 ±0.34	(36) 3.39 ±0.27	(37) 2.45 ±0.19	(35) 1.57 ±0.13	(37) 2.59 ±0.20	(37) 2.60 ±0.37	
24.....	(90) 3.59 ±0.18	(102) 2.00 ±0.08	(90) 3.28 ±0.16	
25.....	(65) 3.63 ±0.22	(91) 6.30 ±0.32	(80) 5.10 ±0.27	(78) 4.74 ±0.26	
26.....	(65) 3.38 ±0.32	(48) 4.81 ±0.35	(34) 3.95 ±0.32	(33) 4.90 ±0.41	
27.....	(61) 2.10 ±0.13	(85) 3.20 ±0.17	(57) 2.60 ±0.16	(59) 3.40 ±0.21	(72) 2.20 ±0.12	2.60 ±0.13	1.80 ±0.10
28.....	(3) 1.48 ±0.57	(3) 2.05 ±0.79	(8) 2.20 ±0.42	(8) 1.65 ±0.50	(11) 3.51 ±0.68	(5) 2.75 ±0.59	(4) 3.64 ±0.87	2.00 ±0.39	1.21 ±0.24	2.54 ±0.49	2.53 ±0.49	3.10 ±0.60	2.30 ±0.44	3.22 ±0.63	1.99 ±0.38	
29.....
30.....	(8) 1.85 ±0.31	(6) 2.51 ±0.48	(11) 2.56 ±0.36	(11) 2.86 ±0.41	(11) 3.88 ±0.56	(11) 3.05 ±0.44	(9) 3.04 ±0.48	(12) 1.37 ±0.19	(12) 2.35 ±0.32	4.06 ±0.54	3.70 ±0.48	6.86 ±0.90	3.23 ±0.42	3.78 ±0.52	4.48 ±0.64
31.....
32.....

STANDARD DEVIATIONS: MALES
 Numbers 23-32—Concluded

Key number	$\frac{100NB}{NHR}$	$\frac{100NB}{NH'}$	$\frac{100O_2R}{O_1R}$	$\frac{100O_2R}{O_1R}$	$\frac{100O_2R}{LacO_1R}$	$\frac{100O_2R}{O_1R}$	$\frac{100G_2}{G_1}$	$\frac{100G_2}{G_1'}$	$\frac{100EH}{G_2}$	$\frac{100fmb}{fml}$	A	B	N	P	Pros. P.Z.	Weight in grms.
23.....	3.67 ±0.28 (124)	4.96 ±0.38 (120)
24.....	4.27 ±0.18	4.57 ±0.20
25.....
26.....
27.....
28.....	3.73 ±0.73 (11)	3.92 ±0.94 (11)	3.73 ±1.02 (8)	3.36 ±0.92 (8)	3.73 ±1.02 (8)	5.28 ±1.13 (7)	4.32 ±0.92 (7)	6.61 ±1.58 (11)	7.11 ±1.38 (4)	7.11 ±1.38 (4)	3.02 ±0.59	1.63 ±0.32	2.81 ±0.55	2.58 ±0.50	1.90 ±0.37	120.40 ±23.44
29.....	3.10 ±0.41 (11)	2.62 ±0.38 (11)	5.50 ±0.92 (9)	6.11 ±1.03 (8)	5.50 ±0.92 (9)	4.05 ±0.73 (11)	4.93 ±0.89 (11)	3.21 ±0.46 (9)	6.01 ±0.79 (12)	6.01 ±0.79 (12)	3.71 ±0.49 (11)	2.11 ±0.28 (11)	3.01 ±0.40 (11)	1.80 ±0.24 (11)	2.00 ±0.26 (11)	68.21 ±9.02 (11)
30.....	4.25 ±0.61 (11)	4.45 ±0.64 (11)	4.52 ±0.65 (19)	3.32 ±0.56 (18)	6.07 ±0.96 (19)	6.83 ±0.98 (18)	6.84 ±0.98 (19)	6.70 ±1.06 (13)	6.59 ±0.90 (19)	6.59 ±0.90 (19)	2.31 ±0.33 (19)	3.00 ±0.43 (19)	1.50 ±0.21 (19)	4.04 ±0.58 (19)	4.28 ±0.61 (19)	63.81 ±9.17 (19)
31.....	4.27 ±0.45 (102)	4.66 ±0.50 (102)	5.55 ±0.61 (102)	6.10 ±0.63 (102)	5.74 ±0.69 (102)	5.97 ±0.67 (102)	6.13 ±0.68 (94)	4.46 ±0.59 (94)	7.18 ±0.76 (100)	7.18 ±0.76 (100)	2.84 ±0.31 (100)	1.92 ±0.21 (100)	3.11 ±0.34 (100)	3.97 ±0.43 (100)	4.33 ±0.47 (96)	130.00 ±10.99 (96)
32.....	4.83 ±0.23	5.27 ±0.40	5.54 ±0.27	5.43 ±0.27	3.32 ±0.23

STANDARD DEVIATIONS: MALES

Numbers 33-41

Key number	Capacity in cc.	L	B	B'	H'	LB	S ₁	S ₁ '	S ₂	S ₂ '	S ₃	S ₃ '	S	GLU	U
33	(54) 6.85 ±0.44	(54) 5.49 ±0.36	(51) 5.46 ±0.36	(49) 3.48 ±0.24
34	(45) 5.87 ±0.42	(44) 4.68 ±0.34	(42) 5.82 ±0.43	(41) 3.39 ±0.25
35	(146) 5.72 ±0.23	(143) 4.75 ±0.19	(103) 4.55 ±0.21	(75) 3.76 ±0.21
36	(48) 4.59 ±0.32	(45) 3.37 ±0.24	(45) 4.65 ±0.33
37	(128) 110.2 ±4.6	(195) 4.58 ±0.19	(188) 4.60 ±0.16	(102) 3.81 ±0.18
38	(40) 4.68 ±0.35	(41) 5.45 ±0.41	(35) 4.48 ±0.36	(34) 4.06 ±0.33
39	(120) 5.19 ±0.23	(120) 4.23 ±0.18	(110) 5.00 ±0.23
40	(36) 75.1 ±6.0	(94) 4.72 ±0.28	(64) 4.48 ±0.27
41	(40) 93.1 ±7.0	(49) 5.13 ±0.34	(47) 5.65 ±0.39

STANDARD DEVIATIONS: MALES
 Numbers 33-41—Continued

Key number	BQ	GB	J	G'H	GL	NHR	NHL	NH'	NB	O ₁ R	O ₂ L	O ₂ R	O ₁ L	O ₁ R	O ₁ L
33	(40) 5.89 ±0.44	(44) 3.83 ±0.28	(42) 4.87 ±0.36	(48) 3.19 ±0.22	(48) 1.72 ±0.12
34	(32) 6.22 ±0.52	(44) 6.04 ±0.43	(39) 4.00 ±0.31	(45) 4.10 ±0.29	(44) 1.77 ±0.13
35	(73) 6.45 ±0.36	(93) 4.34 ±0.21	(54) 4.96 ±0.32	(101) 3.02 ±0.14	(101) 1.80 ±0.09
36	(49) 2.64 ±0.18	(51) 1.88 ±0.13	(44) 1.36 ±0.10	(45) 1.95 ±0.14
37	(172) 5.19 ±0.19	(191) 3.57 ±0.12	(98) 4.38 ±0.21	(199) 2.77 ±0.09	(199) 1.50 ±0.05	(86) 1.37 ±0.07	(141) 1.70 ±0.07
38	(38) 4.97 ±0.38	(36) 4.11 ±0.33	(31) 4.67 ±0.40	(40) 3.03 ±0.23	(40) 1.98 ±0.15
39	(77) 5.98 ±0.33	(70) 3.44 ±0.20	(90)	(90) 2.84 ±0.14	(89) 2.22 ±0.11	(85) 1.38 ±0.07	(87) 1.59 ±0.08
40	(31) 5.91 ±0.51	(36) 3.58 ±0.28	(51)	(51) 2.46 ±0.16	(52) 2.07 ±0.14	(51) 1.45 ±0.10	(51) 1.58 ±0.11
41	(35) 4.87 ±0.39	(41) 3.67 ±0.27	(47)	(47) 2.60 ±0.18	(46) 1.51 ±0.11	(39) 1.36 ±0.10	(39) 1.54 ±0.12

STANDARD DEVIATIONS: MALES
 Numbers 33-41—Continued

Key number	Lac O ₁ R	Lac O ₁ L	DC	G ₁	G ₂	G ₁ '	EH	fml	fmb	100B L	100H' L	100B H'	100(B-H') L	Oel	100G'H GB
33.....	(53) 4.21 ±0.28
34.....	2.42 ±0.18 (139)
35.....	3.24 ±0.13 (44)
36.....	2.43 ±0.17 (191)
37.....	2.90 ±0.10 (40)
38.....	3.12 ±0.24 (120)
39.....	2.95 ±0.13 (98)
40.....	3.07 ±0.15 (49)
41.....	3.31 ±0.23

STANDARD DEVIATIONS: MALES
 Numbers 33-41—*Concluded*

Key number	100NB NHR	1000 ₂ R O ₁ R	1000 ₂ R O ₁ R	1000 ₂ R LacO ₁ R	1000 ₂ R G ₁	100G ₂ G ₁	100EH G ₂	100fmb fml	A Z	B Z	N Z	P Z	Pross. PZ	Weight in grms.
33	5.10 ±0.35 (47)													
34	5.01 ±0.36 (98)													
35	4.16 ±0.20 (48)													
36	3.86 ±0.27 (199)													
37	4.02 ±0.14 (40)													
38	4.90 ±0.37 (89)													
39	4.23 ±0.21 (50)													
40	4.59 ±0.31 (46)													
41	4.49 ±0.32 (85)													

STANDARD DEVIATIONS: MALES

Numbers 42-48

Key number	Capacity in cc.	L	B	B'	H'	LB	S ₁	S ₁ '	S ₂	S ₂ '	S ₃	S ₃ '	S	GLU	U	
42	(57) 95.1 ±6.0	(63) 5.60 ±0.34	(63) 4.70 ±0.28	(61) 3.53 ±0.22	(61) 3.53 ±0.22											
43	(43) 98.4 ±7.2	(51) 5.20 ±0.35	(51) 4.27 ±0.29	(50) 4.95 ±0.33	(50) 4.95 ±0.33											
44	(87) 5.26 ±0.23	(121) 5.63 ±0.24	(121) 5.63 ±0.24	(87) 4.39 ±0.22	(87) 4.39 ±0.22											
45	(117) 6.05 ±0.27	(113) 4.94 ±0.27	(113) 4.94 ±0.27	(103) 5.06 ±0.24	(103) 5.06 ±0.24	(91) 4.43 ±0.22	(104) 6.66 ±0.31	(60) 4.80 ±0.30	(103) 7.86 ±0.37	(103) 7.86 ±0.37	(103) 7.86 ±0.37		(106) 12.65 ±0.59	(108) 14.16 ±0.65		
*46	(506) 123.80 ±2.63	(524) 6.13 ±0.13	(524) 4.81 ±0.10	(425) 4.42 ±0.10	(521) 5.52 ±0.09	(516) 4.20 ±0.09	(522) 6.34 ±0.13	(522) 4.85 ±0.10	(522) 7.79 ±0.16	(522) 5.97 ±0.12	(522) 7.42 ±0.15	(522) 5.31 ±0.11	(522) 13.02 ±0.27	(497) 14.25 ±0.30		
†47	(16) 100.2 ±2.53	(41) 6.04 ±0.10	(42) 4.92 ±0.10	(22) 4.68 ±0.21	(41) 4.74 ±0.08	(28) 4.02 ±0.05	(18) 5.97 ±0.13	(13) 4.32 ±0.08	(18) 7.44 ±0.22	(12) 6.31 ±0.08	(18) 6.61 ±0.05	(13) 4.51 ±0.20	(22) 12.45 ±0.35	(12) 13.98 ±0.56	(24) 13.72 ±0.31	
†48	0.001	0.001	0.017	0.021	0.029	0.046	0.042	0.028	0.083	0.014	0.011	

*Added to the table too late to be included in the inter-racial weighted average.

†Inter-racial standard deviations; these are weighted averages of the series of standard deviations numbered 1-45.

‡Differences in probable errors of the means for traits measured by Howells (No. 45, Irish skulls), using (a) Howells' own standard deviations, then (b) my inter-racial standard deviations.

STANDARD DEVIATIONS: MALES
Numbers 42-48—Continued

Key number	BQ	GB	J	G'H	GL	NHR	NHL	NH'	NB	O'R	O'L	O'R	O'L
42	4.38 ±0.27	(59) 4.38 ±0.27	(56) 3.97 ±0.25	(61) 2.70 ±0.16	(60) 2.18 ±0.13	(57) 1.56 ±0.10	(57) 1.75 ±0.11						
43	4.49 ±0.30	(52) 4.49 ±0.30	(51) 3.43 ±0.23	(53) 2.11 ±0.14	(53) 1.77 ±0.12	(43) 1.13 ±0.08	(43) 1.98 ±0.14						
44	6.11 ±0.36	(65) 6.11 ±0.36	(65) 4.19 ±0.25	(75) 2.85 ±0.16	(73) 1.81 ±0.10								
45	9.24 ±0.43	(104) 9.24 ±0.43	(58) 4.67 ±0.29	(71) 4.05 ±0.23	(55) 5.52 ±0.35	(78) 3.46 ±0.19	(75) 2.04 ±0.11	(76) 2.29 ±0.13	(66) 1.83 ±0.11	(70) 2.15 ±0.12			
46	10.94 ±0.25	(420) 10.94 ±0.25	(466) 4.89 ±0.12	(423) 4.53 ±0.11	(423) 5.16 ±0.12	(519) 3.25 ±0.07	(514) 3.20 ±0.07	(372) 3.39 ±0.08	(523) 1.78 ±0.04	(501) 1.71 ±0.04	(494) 2.07 ±0.04		
47	9.31 ±0.36	(18) 9.31 ±0.36	(31) 5.24 ±0.12	(36) 4.69 ±0.09	(24) 4.80 ±0.14	(25) 3.03 ±0.07	(14) 3.04 ±0.10	(12) 3.06 ±0.14	(32) 1.78 ±0.04	(20) 1.67 ±0.08	(15) 1.62 ±0.05	(7) 1.83 ±0.08	(10) 1.68 ±0.09
48	0.005	0.005	0.050	0.051	0.066	0.033	0.033	0.001	0.029	0.025	0.017	0.022	0.022

STANDARD DEVIATIONS: MALES
 Numbers 42-48—Continued

Key number	Lac O ₁ R	Lac O ₁ L	DC	G ₁	G ₂	G ₁ '	EH	fml	fmb	$\frac{100B}{L}$	$\frac{100H'}{L}$	$\frac{100B}{H'}$	$\frac{100(B-H')}{L}$	OcI	$\frac{100G'H}{GB}$
42.....										(63) 3.03 ±0.18					
43.....										(51) 3.20 ±0.21					
44.....										(121) 2.93 ±0.13					
45.....			(69) 2.41 ±0.14							(111) 3.11 ±0.20	(102) 3.00 ±0.14	(100) 4.83 ±0.23			
46.....				(239) 3.49 ±0.11	(239) 2.99 ±0.09	(237) 3.17 ±0.10		(421) 2.43 ±0.06	(421) 2.23 ±0.05	(524) 2.62 ±0.05	(521) 3.00 ±0.06		(521) 4.84 ±0.10		(329) 5.67 ±0.15
47.....	(8) 1.43 ±0.07	(6) 1.99 ±0.01	(14) 2.45 ±0.14	(14) 3.12 ±0.12	(17) 2.97 ±0.08	(12) 2.97 ±0.07	(9) 2.32 ±0.17	(23) 2.52 ±0.06	(20) 2.03 ±0.05	(40) 3.37 ±0.07	(27) 3.07 ±0.07	(22) 4.64 ±0.14	(10) 2.90 ±0.14	(13) 3.17 ±0.12	(14) 4.17 ±0.15
48.....			0.003							0.017	0.005	0.013			

STANDARD DEVIATIONS: MALES
 Numbers 42-48—*Concluded*

Key number	$\frac{100NB}{NH'}$	$\frac{100O_2R}{O_2R}$	$\frac{100O_2R}{O_2R}$	$\frac{100O_2R}{O_2R}$	$\frac{100G_2}{G_2}$	$\frac{100EH}{G_2}$	$\frac{100fmb}{fmb}$	A	B	N	P	Pros. P.L.	Weight in kms.
42	(60) 4.01 ±0.25	$\frac{100O_2R}{O_2R}$ (57) 3.98 ±0.25	$\frac{100O_2R}{O_2R}$ (57) 3.98 ±0.25
43	(53) 3.63 ±0.24	$\frac{100O_2R}{O_2R}$ (43) 4.53 ±0.33	$\frac{100O_2R}{O_2R}$ (43) 4.53 ±0.33
44	(73) 3.69 ±0.21
45	(69) 4.07 ±0.23	$\frac{100O_2R}{O_2R}$ (71) 5.87 ±0.23	$\frac{100O_2R}{O_2R}$ (71) 5.87 ±0.23
46	(421) 4.17 ±0.10	(372) 4.61 ±0.11	(239) 7.41 ±0.23	(421) 5.28 ±0.13	(423) 3.22 ±0.07	(423) 2.94 ±0.07	(423) 3.64 ±0.08	(332) 3.10 ±0.08
47	(28) 4.12 ±0.06	(18) 4.71 ±0.13	(19) 4.98 ±0.12	(15) 4.70 ±0.17	(12) 6.19 ±0.21	(8) 5.00 ±0.39	(17) 6.14 ±0.12	(11) 3.24 ±0.14	(12) 2.40 ±0.09	(12) 3.32 ±0.14	(14) 3.36 ±0.14	(9) 3.73 ±0.25	(6) 93.2 ±0.71
48	0.004

STANDARD DEVIATIONS: FEMALES

Numbers 1-5

Key number	Capacity in cc.	L	B	B'	H'	LB	S ₁	S ₁ '	S ₂	S ₂ '	S ₃	S ₃ '	S	GLU	U
1	98.68 ±14.19 (472)	6.60 ±0.94 (589)	3.23 ±0.46 (578)	3.33 ±0.48 (582)	5.15 ±0.74 (582)	3.39 ±0.49 (595)	6.65 ±0.96 (617)	5.11 ±0.73 (606)	6.79 ±0.97 (606)	5.35 ±0.77 (594)	6.75 ±0.97 (593)	4.92 ±0.71 (594)	16.12 ±2.32 (583)	13.53 ±1.94 (583)	14.35 ±2.06 (583)
2	92.06 ±2.02 (83)	4.72 ±0.08 (83)	4.52 ±0.09 (86)	3.79 ±0.07 (86)	4.37 ±0.09 (86)	3.52 ±0.07 (86)	5.65 ±0.11 (86)	6.43 ±0.12 (86)	6.77 ±0.13 (84)	4.75 ±0.09 (84)	10.49 ±0.21 (84)	11.76 ±0.23 (84)
3	98.5 ±5.20 (67)	5.95 ±0.30 (67)	5.44 ±0.28 (67)	4.30 ±0.22 (58)	4.68 ±0.24 (71)	3.40 ±0.17 (66)	6.02 ±0.31 (66)	4.35 ±0.22 (66)	6.65 ±0.34 (66)	5.33 ±0.28 (66)	7.58 ±0.39 (60)	5.17 ±0.26 (60)	12.99 ±0.66 (60)	12.51 ±0.65 (60)
4	80.1 ±4.70 (12) ±4.70 (12)	4.54 ±0.25 (12)	3.69 ±0.23 (11)	5.30 ±0.30 (11)	4.16 ±0.24 (11)	11.05 ±0.68 (12)
5	76.43 ±10.52	4.20 ±0.55	4.76 ±0.63	4.50 ±0.59	3.75 ±0.54	3.22 ±0.46	6.07 ±0.80	3.32 ±0.44	7.44 ±0.98	68.4 ±0.98	4.37 ±0.63	2.87 ±0.41	9.58 ±1.27	12.06 ±1.59

Key number	BQ'	GB	J	G'H	GL	NHR	NHL	NH'	NB	O ₁ R	O ₂ R	O ₃ R	O ₁ L	O ₂ L	O ₃ L	O ₁ 'R	O ₁ 'L
1	11.75 ±1.69 (579)	3.71 ±0.56 (581)	(10) 3.46 ±0.52 (500)	4.85 ±1.03 (567)	4.16 ±0.60 (563)	3.09 ±0.44 (593)	2.47 ±0.35	2.77 ±0.40	1.85 ±0.27 (591)	1.66 ±0.24 (589)	1.39 ±0.20 (595)	1.39 ±0.20 (595)	2.50 ±0.36 (587)	1.85 ±0.27 (590)	1.85 ±0.27 (590)	1.43 ±0.20	2.60 ±0.37
2	8.84 ±0.18 (84)	4.35 ±0.09 (85)	4.38 ±0.09 (71)	3.76 ±0.08 (72)	4.08 ±0.08 (70)	2.60 ±0.05 (86)	1.64 ±0.03 (85)	1.56 ±0.03 (85)	1.84 ±0.04 (84)	1.57 ±0.03 (84)	1.89 ±0.04 (82)	1.89 ±0.04 (82)	1.89 ±0.04 (82)
3	10.33 ±0.54	4.67 ±0.24	4.85 ±0.27	3.42 ±0.19	4.50 ±0.26	2.26 ±0.12	2.34 ±0.12	2.51 ±0.13	1.81 ±0.09	1.76 ±0.09	1.86 ±0.10	1.86 ±0.10	1.70 ±0.08	1.81 ±0.10	1.81 ±0.10	2.01 ±0.13
4	5.84 ±0.35	1.89 ±0.13	2.14 ±0.14
5	8.60 ±1.14	4.08 ±0.54	2.73 ±0.36	2.02 ±0.27	1.53 ±0.30	2.48 ±0.33

STANDARD DEVIATIONS: FEMALES
Numbers 1-5—Concluded

Key number	Lac O ₁ R	Lac O ₂ L	DC	G ₁	G ₂	G ₁ '	EH	fml	fmb	100B L	100H' L	100B H'	100(B-H') L	Ocl	100G'H GB	
1	(8) 2.13 ±0.36	(7) 1.57 ±0.28	1.51 ±0.32	(10) 3.46 ±0.74 (552)	(10) 2.21 ±0.33 (462)	(10) 3.69 ±0.56 (560)	(8) 2.29 ±0.39	2.35 ±0.34 (602)	1.82 ±0.37 (607)	2.42 ±0.35 (584)	1.89 ±0.27 (570)	3.30 ±0.47 (570)	1.94 ±0.28	2.90 ±0.42 (592)	(10) 5.69 ±0.76 (547)	
2	(54) 1.77 ±0.11	(79) 1.89 ±0.10	(79) 1.89 ±0.10	(64) 2.91 ±0.17 (68)	(44) 2.20 ±0.16 (42)	(68) 2.74 ±0.16 (86)	(42) 2.24 ±0.16	2.19 ±0.11 (65)	1.88 ±0.10 (54)	3.83 ±0.20 (86)	3.44 ±0.18 (86)	5.18 ±0.27 (86)	3.51 ±0.18	3.04 ±0.16	(70) 4.72 ±0.27	
4	(10) 1.42 ±0.21	(10) 1.42 ±0.21	(10) 1.42 ±0.21	(10) 1.27 ±0.19	(10) 1.27 ±0.19	(10) 1.27 ±0.19	(10) 1.27 ±0.19	(10) 1.27 ±0.19	(10) 1.27 ±0.19	(10) 1.27 ±0.19	(10) 1.27 ±0.19	(10) 1.27 ±0.19	(10) 1.27 ±0.19	(10) 1.27 ±0.19	(10) 1.27 ±0.19	(10) 1.27 ±0.19
5	(10) 1.42 ±0.21	(10) 1.42 ±0.21	(10) 1.42 ±0.21	(10) 1.27 ±0.19	(10) 1.27 ±0.19	(10) 1.27 ±0.19	(10) 1.27 ±0.19	(10) 1.27 ±0.19	(10) 1.27 ±0.19	(10) 1.27 ±0.19	(10) 1.27 ±0.19	(10) 1.27 ±0.19	(10) 1.27 ±0.19	(10) 1.27 ±0.19	(10) 1.27 ±0.19	(10) 1.27 ±0.19

Key number	100NB NHR	100NB NH'	100O ₂ R O ₁ 'R	100O ₂ R O ₂ 'R	100O ₂ R LacO ₂ R	100G ₂ G ₁	100G ₂ G ₁ '	100EH G ₂	100fmb fml	A Z	B Z	N Z	P Z	Pres. PZ	Weight in gms.
1	4.41 ±0.63 (580)	5.29 ±0.76 (80)	3.42 ±0.49 (585)	3.85 ±0.55 (55)	4.48 ±0.75 (53)	7.76 ±1.17 (432)	9.65 ±1.45 (39)	5.70 ±0.96 (42)	5.94 ±0.85 (597)	3.20 ±0.48 (550)	2.52 ±0.38 (550)	3.59 ±0.54 (550)	3.20 ±0.48 (529)	3.00 ±0.45	72.02 ±21.71
2	3.77 ±0.07 (85)	4.09 ±0.21 (58)	4.59 ±0.23 (84)	4.59 ±0.09 (84)	4.17 ±0.33 (53)	6.58 ±0.15 (39)	7.18 ±0.53 (42)	5.62 ±0.11 (86)	6.50 ±0.42 (55)	3.41 ±0.07 (70)	2.33 ±0.05 (70)	3.26 ±0.07 (70)	2.95 ±0.06 (72)	(69)	(69)
3	4.93 ±0.65	5.34 ±0.71	5.34 ±0.71	5.34 ±0.71	5.34 ±0.71	5.34 ±0.71	5.34 ±0.71	5.34 ±0.71	5.34 ±0.71	5.34 ±0.71	5.34 ±0.71	5.34 ±0.71	5.34 ±0.71	5.34 ±0.71	5.34 ±0.71

STANDARD DEVIATIONS: FEMALES
Numbers 6-15

Key number	Capacity in cc.	L	B	B'	H'	LB	S ₁	S ₁ '	S ₂	S ₂ '	S ₃	S ₃ '	S	GLU	U
6.....	(19) 76.02 ±8.32	4.75 ±0.49	4.20 ±0.47	3.15 ±0.33	5.05 ±0.53 (60)	4.10 ±0.42 (60)	6.60 ±0.70 (20)	6.24 ±0.65	7.21 ±0.75	5.79 ±0.60 (24)	4.57 ±0.48 (54)	3.71 ±0.40 (54)	10.34 ±0.11 (20)	9.60 ±1.00	10.24 ±1.06
7.....	75.52 ±4.30	5.12 ±0.29	4.60 ±0.26	3.04 ±0.17	4.85 ±0.30	3.81 ±0.24	5.52 ±0.32	3.78 ±0.21	6.27 ±0.36	5.05 ±0.29	6.09 ±0.39	4.43 ±0.29	10.29 ±0.66	11.31 ±0.65	10.25 ±0.59
8.....	109.00 ±11.34	5.10 ±0.50	4.15 ±0.40	3.05 ±0.28	5.47 ±0.53	3.63 ±0.34	6.50 ±0.63	4.78 ±0.46	6.96 ±0.67	5.55 ±0.54	6.30 ±0.60	4.82 ±0.46	13.97 ±1.36	12.28 ±1.22	12.68 ±1.23
9.....	4.98 ±0.31	4.39 ±0.27	3.94 ±0.24	4.04 ±0.28	3.45 ±0.24	5.85 ±0.36	6.42 ±0.39	5.63 ±0.38	11.66 ±0.80	12.09 ±0.75
10.....	(259) 5.09	4.55	4.37	(213) 5.05	(206) 4.24	(248) 5.75	(248) 4.11	(249) 7.16	(251) 5.48	(215) 6.68	(216) 4.52	(212) 11.48	(214) 12.48
11.....	4.79 ±0.40	4.07 ±0.34	3.19 ±0.26	5.42 ±0.46	3.55 ±0.31	7.93 ±0.66	6.36 ±0.53	5.82 ±0.48	13.36 ±1.11	13.49 ±1.12
12.....	4.54 ±0.22	4.00 ±0.24
13.....	(54) 83.48 ±5.42	8.31 ±0.47	(68) 5.43 ±0.31	(55) 4.00 ±0.26	(40) 4.06 ±0.31	(62) 12.24 ±0.74	(66) 12.52 ±0.74
14.....	81.16 ±8.45	5.98 ±0.56	6.14 ±0.59	4.03 ±0.42	7.80 ±0.74	(23) 9.80 ±0.98
15.....	(364) 101.50 ±2.54	(374) 5.19 ±0.13	(374) 4.40 ±0.11	(374) 4.16 ±0.10	(372) 4.63 ±0.11	(370) 3.81 ±0.09	(377) 5.95 ±0.15	(377) 4.47 ±0.11	(377) 6.91 ±0.17	(377) 5.42 ±0.13	(376) 6.91 ±0.17	(376) 4.73 ±0.12	(376) 11.73 ±0.29	(370) 12.51 ±0.31

STANDARD DEVIATIONS: FEMALES
 Numbers 6-15—Continued

Key number	BQ	GB	J	G'H	GL	NHR	NHL	NH'	NB	O ₁ R	O ₂ R	O ₁ L	O ₂ L	O ₁ 'R	O ₁ 'L	
6	9.95 ±1.03	3.86 ±0.44 (68)	2.80 ±0.33 (67)	4.87 ±0.60 (15)	4.82 ±0.59 (15)	3.29 ±0.36 (19)	3.12 ±0.35 (18)	3.25 ±0.38 (17)	1.91 ±0.21 (19)	1.16 ±0.13 (19)	1.57 ±0.17 (19)	1.44 ±0.16 (18)	1.12 ±0.13 (18)	1.24 ±0.17 (12)	1.47 ±0.22 (10)	
7	9.28 ±0.53 (23)	4.43 ±0.26 (24)	5.28 ±0.31 (17)	4.76 ±0.27 (25)	4.97 ±0.30 (24)	3.24 ±0.18 (20)	3.19 ±0.18 (20)	3.18 ±0.18 (25)	1.72 ±0.09 (25)	1.38 ±0.08 (67)	2.10 ±0.12 (69)	1.43 ±0.08 (69)	2.13 ±0.12 (69)	1.88 ±0.15 (33)	1.38 ±0.12 (29)	
8	10.87 ±1.08	4.31 ±0.42	4.98 ±0.57	4.58 ±0.44	3.41 ±0.33	3.72 ±0.37	2.59 ±0.28	1.62 ±0.15	1.69 ±0.15
9	9.21 ±0.62 (234)
10	9.98 ±0.29	4.04 ±0.21 (81)	4.28 ±0.32 (40)	3.94 ±0.20 (87)	4.65 ±0.25 (76)	2.70 ±0.12 (116)	1.73 ±0.09 (88)	1.55 ±0.11 (11)	1.67 ±0.11 (112)
11	9.98 ±0.83	2.65 ±0.23 (31)	4.63 ±0.42 (27)	3.45 ±0.29 (29)	3.28 ±0.29	2.18 ±0.18	1.28 ±0.11 (86)	1.89 ±0.16 (77)	2.21 ±0.19 (78)
12	3.36 ±0.19 (68)	2.24 ±0.12 (86)	3.44 ±0.19	1.83 ±0.09	1.63 ±0.09	1.65 ±0.08	1.46 ±0.08	1.85 ±0.10
13	11.30 ±0.65 (68)
14	12.46 ±1.30 (368)
15	9.39 ±0.23	3.94 ±0.10 (346)	4.07 ±0.11 (327)	4.07 ±0.12 (279)	4.92 ±0.14 (279)	2.74 ±0.07 (370)	2.73 ±0.07 (369)	3.06 ±0.10 (230)	1.89 ±0.05 (372)	1.60 ±0.04 (354)	1.93 ±0.05 (354)	1.62 ±0.04 (353)	1.95 ±0.05 (353)

STANDARD DEVIATIONS: FEMALES
Numbers 6-15—Continued

Key number	Lac O ₁ R	Lac O ₂ L	DC	G ₁	G ₂	G ₁ '	EH	fml	fmb	$\frac{100B}{L}$	$\frac{100H'}{L}$	$\frac{100B}{H'}$	$\frac{100(B-H')}{L}$	Ocl	$\frac{100G'H}{GB}$
6.....	(4) 1.13 ±0.27	(4) 0.45 ±0.11	(21) 1.53 ±0.16	(13) 3.49 ±0.46	(17) 2.37 ±0.28	(13) 2.76 ±0.36	(13) 2.03 ±0.27	(20) 1.51 ±0.16	(21) 1.33 ±0.13	(21) 3.76 ±0.39	(21) 2.95 ±0.30	(21) 6.18 ±0.64	(21) 4.49 ±0.46	(20) 5.17 ±0.55	(13) 5.77 ±0.76
7.....	(30) 1.57 ±0.13	(29) 1.60 ±0.14	(20) 1.90 ±0.11	(63) 3.50 ±0.21	(68) 2.54 ±0.15	(65) 3.26 ±0.19	(57) 1.68 ±0.11	(53) 2.18 ±0.14	(53) 1.88 ±0.12	(24) 3.74 ±0.21	(60) 3.12 ±0.19	(60) 5.51 ±0.34	(60) 3.90 ±0.24	(54) 3.84 ±0.25	(68) 5.86 ±0.34
8.....	(20) 2.59 ±0.28	(25) 2.45 ±0.24	(24) 2.36 ±0.24	(24) 2.45 ±0.24	(23) 4.06 ±0.40	(25) 1.87 ±0.17
9.....	2.37 ±0.17	1.93 ±0.13	2.47 ±0.16	2.37 ±0.16	4.20 ±0.29	2.52 ±0.17
10.....	(68) 2.28 ±0.13	(90) 3.00 ±0.15	2.14 ±0.07	1.99 ±0.07	(252) 2.99 ±0.09	(209) 2.92 ±0.10	(206) 5.11 ±0.17	(202) 3.52 ±0.12	(215) 2.48 ±0.08	(59) 5.14 ±0.32
11.....	(26) 1.98 ±0.18	(27) 1.81 ±0.17	(31) 1.81 ±0.15	(31) 1.99 ±0.17	2.21 ±0.18	2.54 ±0.22	3.37 ±0.29
12.....	(61) 4.75 ±0.29	(73) 1.66 ±0.13	(61) 2.62 ±0.16
13.....	4.78 ±0.36	(68) 6.53 ±0.38	(55) 4.36 ±0.28	(53) 4.09 ±0.25
14.....	(21) 4.67 ±0.49	(25) 5.96 ±0.57	(21) 3.36 ±0.35	(21) 4.16 ±0.43
15.....	(219) 3.22 ±0.10	(219) 2.72 ±0.09	(219) 2.92 ±0.09	(368) 2.15 ±0.05	(368) 2.03 ±0.05	(374) 2.81 ±0.07	(370) 2.90 ±0.07	(372) 4.74 ±0.12	(270) 5.13 ±0.15

STANDARD DEVIATIONS: FEMALES
 Numbers 6-15—Concluded

Key number	100NB NHR	100NB NH'	100O ₂ R O ₂ R	100O ₂ R LacO ₂ R	100G ₂ G ₁	100G ₂ G ₁ '	100EH G ₂	100fmb fml	A Z	B Z	N Z	P Z	Pros. P.Z	Weight in gms.
6	(19) 6.43 ±0.70	(17) 7.10 ±0.82 (68)	(19) 3.75 ±0.41 (67)	(12) 1.78 ±0.42 (30)	(13) 6.13 ±0.81 (62)	(13) 6.53 ±0.86 (65)	(13) 5.93 ±0.78 (57)	(20) 5.00 ±0.53 (53)	(15) 2.83 ±0.35 (60)	(15) 2.55 ±0.32 (60)	(15) 3.16 ±0.39 (60)	(15) 3.06 ±0.38 (66)	(15) 3.57 ±0.44 (66)	(17) 71.04 ±8.21
7	4.57 ±0.26 (25)	5.15 ±0.30	6.09 ±0.36	6.01 ±0.50	6.09 ±0.37	6.59 ±0.39	4.37 ±0.26	6.15 ±0.40	3.24 ±0.19	2.92 ±0.18	3.46 ±0.21	3.93 ±0.23	3.73 ±0.21	
8	4.49 ±0.42		3.74 ±0.35					6.07 ±0.63	2.88 ±0.32	3.28 ±0.36	2.63 ±0.29	4.39 ±0.48	3.61 ±0.38	
9	4.73 ±0.34 (84)		3.98 ±0.27 (100)											
10	3.81 ±0.20		4.50 ±0.21 (31)			(55) 5.73 ±0.37 (28)		(167) 5.31 ±0.20 (30)	(75) 3.50 ±0.19	(75) 2.90 ±0.16	(75) 3.79 ±0.21	(62) 3.23 ±0.20		
11	7.62 ±0.64 (86)		5.90 ±0.50 (83)			7.17 ±0.65		5.05 ±0.44					2.77 ±0.23	
12	4.13 ±0.21		4.81 ±0.25											
13														
14	(370) 4.17 ±0.10	(230) 4.84 ±0.15			(218) 6.90 ±0.22			(368) 4.90 ±0.12	(280) 3.21 ±0.09	(280) 2.74 ±0.08	(280) 3.35 ±0.10	(267) 2.86 ±0.08		

BIBLIOGRAPHY

ADACHI, B.

1904. Die Orbita und die Hauptmasse des Schädels der Japaner und die Methode Orbitalmessung. *Zeitschrift für Morphologie*, Bd. 7, pp. 379-480.

ANDREWS, J. M.

1939. A nomogram for computation of probable errors of differences. *Human Biology*, vol. 2, No. 4, pp. 543-545.

ASHLEY-MONTAGU, M. F.

1927. A proposal for a new base-line for use in craniometric investigations. *Man*, No. 128.
1937. The medio-frontal suture and the problem of metopism in the primate. *Journal of the Royal Anthropological Institute*, vol. 67, pp. 157-202.
1938. Aging of the skull. *American Journal of Physical Anthropology*, vol. 23, pp. 355-375.
1941. Physical anthropology and anatomy. *American Journal of Physical Anthropology*, vol. 28, pp. 261-271.
- 1942a. The genetical theory of race and anthropological method. *American Anthropologist*, vol. 44, pp. 369-375.
- 1942b. Man's most dangerous myth. The fallacy of race. New York.

AUSTRALIA, OFFICIAL HANDBOOK

1942. Australian News and Information Bureau, 610 Fifth Avenue, New York City.

AZIZ, C.

1929. Etude morphologique des crânes néo-calédoniens et de nègres africains. *Revue Anthropologique*, vol. 39, pp. 116-146.

BALFOUR, H.

1901. Memorial heads in Pitt-Rivers museum. *Man*, No. 51.
Well illustrated.

BARTELS, P.

1896. Eine neue Methode der Capacitätsbestimmung des Schädels. *Zeitschrift für Ethnologie, Verhandlungen der Berliner Gesellschaft für Anthropologie*, vol. 28, pp. 256-262.

BAUER, F.

1902. Ueber Schädel von den Philippinen. *Archiv für Anthropologie*, Bd. 27, pp. 107-116.

BAUER, L.

1915. Beiträge zur Kraniologie der Baining (Neu-Pommern). *Archivio per l'Antropologia e la Etnologia*, Bd. 14, pp. 145-193.

BENEDICT, R.

1940. Race, science, and politics. New York.

BENINGTON, R. C., and PEARSON, K.

1911. Cranial type-contours. *Biometrika*, vol. 8, pp. 123-201.

BERRY, R. J. A., and ROBERTSON, A. W. D.

1914. The place in nature of the Tasmanian aboriginal as deduced from a study of his calvaria. His relation to the Australian aboriginal. *Proceedings of the Royal Society of Edinburgh*, vols. 34-35, pp. 144-189.

— and ST. CROSS, K.

1910. A biometrical study of the relative degree of purity of race of the Tasmanian, Australian, and Papuan. *Proceedings of the Royal Society of Edinburgh*, vol. 31, pp. 17-40.

BERTILLON, A.

1872. Des divers groupes de crânes néo-calédoniens. *Revue d'Anthropologie*, vol. 1, pp. 250-288.

BEST, E.

1912. Polynesian navigators: Their exploration and settlement of the Pacific. *Geographical Review*, vol. 5, pp. 169-182.

BIJLMER, H. J. T.

1923. Anthropological results of the Dutch Scientific Central New-Guinea expedition, 1920, followed by an essay on the anthropology of the Papuans. *Nova Guinea*, vol. 7, pp. 355-448.

See extensive bibliography (241 titles quoted), pp. 442-448.

1939. Tapiro Pygmies and Pania Mountain Papuans. *Nova Guinea*, new series, vol. 3, pp. 113-184.

BIOLOGICAL ABSTRACTS

1926-. Beginning with the literature of 1926. Union of American Biological Societies. Philadelphia.

BIRDSELL, J. B.

1941. Trihybrid origin of the Australian aborigine. Doctor's thesis accepted by Harvard University; copies deposited in the Widener Library and the Peabody Museum Library.

— and BOYD, W. C.

1940. Blood groups in the Australian aborigines. *American Journal of Physical Anthropology*, vol. 27, pp. 69-90.

BLACK, D.

1928. A study of Kansu and Honan skulls. *Palaeontologia Sinica*, vol. 6, fasc. 1, series D, pp. 1-83.

BOAS, F.

1912. Changes in the bodily form of descendants of emigrants. *American Anthropologist*, vol. 14, pp. 530-562.

BOLK, L.

1915. On the premature obliteration of sutures in the human skull. *American Journal of Anatomy*, vol. 17, pp. 495-523.

BONDY-HOROWITZ, E. VON

1930. Beiträge zur Anthropologie von Nordost-Neu-Guinea. Bibliography, pp. 148-152. Vienna.

BONIN, G. VON

1930. Der Koeffizient der Rassenähnlichkeit und seine Anwendung am Lebenden. *Anthropologische Anzeiger*, vol. 7, pp. 82-102.

1931a. Beiträge zur Kraniologie von Ost-Asien. *Biometrika*, vol. 23, pp. 52-113.

- 1931b. A contribution to the craniology of the Easter Islanders. *Biometrika*, vol. 23, pp. 249-270.
1934. On the size of man's brain as indicated by skull capacity. *Journal of Comparative Neurology*, vol. 59, pp. 1-28.
1936. On the craniology of Oceania. *Crania from New Britain*. *Biometrika*, vol. 28, pp. 123-147.
- and MORANT, G. M.
1938. Indian races in the United States. A survey of previously published cranial measurements. *Biometrika*, vol. 30, pp. 94-129.
- BOROVANSKY, L.
1936. Sex differences in the human skull. *American Journal of Physical Anthropology*, vol. 22, pp. 162-163.
- BOURGAREL, A.
1860. Sur les crânes des Néo-Calédoniens et des Polynésiens. *Bulletins de la Société d'Anthropologie de Paris*, vol. 1, pp. 441-452.
- BOYD, W. C.
1939. Blood groups. *Tabulae Biologicae*, vol. 17, pp. 111-240.
1940. Critique of methods of classifying mankind. *Human Biology*, vol. 27, pp. 333-364.
- BREWSTER, A. B.
1922. *The hill tribes of Fiji*. London and Philadelphia.
Contains a useful large-scale map of Viti Levu.
- BRIGHAM, W. T.
1900. Index to the islands of the Pacific Ocean. *Memoirs, Bernice P. Bishop Museum*, vol. 1, pp. 33-170.
An excellent directory with numerous maps.
- BROEK, A. J. P. VAN DEN
1913. Ueber Pygmäen in Niederländisch-Süd-Neu-Guinea. *Zeitschrift für Ethnologie*, vol. 45, pp. 23-44.
- 1923a. Untersuchungen an Schädeln aus Niederländisch-Süd-West-Neu-Guinea. *Nova Guinea*, vol. 7, pp. 163-233.
- 1923b. Zur Anthropologie des Bergstammes Pesechem, im Inneren von Niederländisch-Neu-Guinea. *Nova Guinea*, vol. 7, pp. 233-276.
- BÜCHNER, L. W. G.
1914. A study of the curvatures of the Tasmanian aboriginal cranium. *Proceedings of the Royal Society of Edinburgh*, vols. 34-35, pp. 128-143.
- BUCK, P. H. (TE RANGI HIROA)
- 1922-23. Maori somatology. *Journal of the Polynesian Society*, vol. 31, pp. 37-41, 145-153, 159-170; vol. 32, pp. 21-28, 189-199.
1938. *Vikings of the sunrise (a story of Pacific migrations)*. New York.
- BURKITT, A. N., and HUNTER, J. I.
- 1922-23. Description of a Neanderthaloid Australian skull. *Journal of Anatomy*, vol. 57, pp. 31-53.
- and LIGHTOLLER, G. H. S.
- 1922-23. Preliminary observations on the nose of the Australian aboriginal. *Journal of Anatomy*, vol. 57, pp. 295-312.

BURSTON, R.

1913. Records of the anthropometric measurements of 102 Australian aborigines. *Bulletin of the Northern Territories of Australia*, No. 7A.

BURTON, J. W.

1910. *The Fiji of today*. London.
Contains excellent photographs of Fijian types.

BUSK, G.

1876. Note on a collection of skulls from the islands of Mallicollo and Vanikoro in the New Hebrides group. *Journal of the Anthropological Institute*, vol. 6, pp. 200-206, with plates.

BUXTON, L. H. D., and MORANT, G. M.

1933. The essential craniological technique. *Journal of the Royal Anthropological Institute*, vol. 63, pp. 19-47.

CAMPBELL, T. D.

1925. Dentition and palate of the Australian aboriginal. *Publications under the Keith Sheridan Foundation*, No. 1. Adelaide, Australia.

— and GRAY, J. H.

1936. Observations on teeth of Australian aborigines. *Australian Journal of Dentistry*, vol. 40, pp. 290-295.

—, GRAY, J. H., and HACKETT, C. J.

1936. Physical anthropology of the aborigines of central Australia. *Oceania*, vol. 7, pp. 106-139, 246-261.

— and HACKETT, C. J.

1928. Adelaide University Field Anthropological Expedition to Central Australia. *Transactions of the Royal Society of South Australia*, vol. 52, pp. 55-75.

— and LEWIS, A. J.

1926. Aborigines of South Australia; anthropometric, descriptive, and other observations recorded at Ooldea. *Transactions of the Royal Society of South Australia*, vol. 50, pp. 183-191.

CAVE, A. J. E.

1936. On the human crania from New Guinea, collected by Lord Moyne's expedition, and now in the Royal College of Surgeons, London. Windmill Press, Kingswood, Surrey. Privately printed.

CHINNERY, E. W. P.

1925. Territory of New Guinea. *Anthropological Report No. 2*. Notes on the natives of E. Mira and St. Matthias. Appendix 2. Physical measurements on living subjects, pp. 216-220.

Consult SHAPIRO, H. L. (1933), for bibliography of Chinnery's works.

CHURCHILL, W.

1911. *The Polynesian wanderings*. Tracks of the migration deduced from an examination of the Proto-Samoan content of Efaté and other languages of Melanesia. Carnegie Institution of Washington, Publication No. 134.

COBB, W. M.

1942. Physical anthropology of the American Negro. *American Journal of Physical Anthropology*, vol. 29, pp. 114-192.
Anatomical, physiological, social data.

CODRINGTON, R. H.

1885. *The Melanesian languages*. Oxford.

1891. *The Melanesians: studies in their anthropology and folklore*. Oxford.

COLE, FAY-COOPER, and DEUEL, T.

1937. *Rediscovering Illinois*. University of Chicago Press, Chicago.

COLLINS, H. B.

1926. The temporo-frontal articulation in man. *American Journal of Physical Anthropology*, vol. 9, pp. 343-348.

COLONIAL OFFICE DOCUMENTS

1937. No. 1879: Gilbert and Ellice Islands Colony. British Library of Information, New York.

1938a. No. 1918: Tongan Islands Protectorate. British Library of Information, New York.

1938b. No. 1928: New Hebrides. British Library of Information, New York.

CREWDSON-BENINGTON, R.

1912. A study of the Negro skull with special reference to the Congo and Gaboon crania. *Biometrika*, vol. 8, pp. 292-339.

DAHLBERG, G.

1942. An analysis of the conception of race, and a new method of distinguishing races. *Human Biology*, vol. 14, pp. 372-385.

DAVENPORT, C. B.

1925. Notes on physical anthropology of Australian aborigines and black-white hybrids. *American Journal of Physical Anthropology*, vol. 8, pt. 1, pp. 73-94.

DAVIDSON, D. S.

1938. An ethnic map of Australia. *Proceedings of the American Philosophical Society*, vol. 79.

DAVIES, A.

1932. A re-survey of the morphology of the nose in relation to climate. *Journal of the Royal Anthropological Institute*, vol. 62, pp. 337-359.

DAVIS, J. B.

1867. *Thesaurus craniorum*. Catalogue of the skulls of the various races of man in the collection of Joseph Barnard Davis. London. New Hebrides, p. 373.

Well indexed.

DEACON, A. B.

1927. The regulation of marriage in Ambrym. *Journal of the Royal Anthropological Institute*, vol. 57, pp. 325-342.

1929. Notes on some islands of the New Hebrides. *Journal of the Royal Anthropological Institute*, vol. 59, pp. 461-515.

1934. *Malekula: a vanishing people in the New Hebrides*. London.

Deals with general ethnology, gives a bibliography, and is well illustrated.

DE BEAUFORT, L. F., PULLE, A. A., and RUTTEN, L.

1926. *Nova Guinea. Résultats des expéditions scientifiques à la Nouvelle Guinea*, vol. 15. Leiden. See P. WIRZ.

DENIKER, J.

1893. *Les indigènes de Lifou (Iles Loyauté)*. *Bulletins de la Société d'Anthropologie de Paris*, vol. 4, No. 4.

1926. *Les races et les peuples de la terre*. Second edition. Paris.

DINGWALL, E. J.

1931. Artificial cranial deformation. London. New Hebrides, p. 137.

DOBSON, G. E.

1875. On the Andamans and Andamanese. *Journal of the Anthropological Institute*, vol. 4, pp. 457-467.

DORDILLON, R. I.

1931-32. Grammaire et dictionnaire de la langue des Iles Marquises. *Travaux et Mémoires de l'Institut d'Ethnologie*, Paris, vol. 17, pp. 1-446; vol. 18, pp. 1-598 (two vols.).

DORSEY, G. A.

1897. Observations on a collection of Papuan crania. *Field Columbian Museum Publication 21, Anthropological Series*, vol. 2, No. 1.

DRENNAN, M. R.

1929. The dentition of a Bushman tribe. *Annals of the South African Museum*, Capetown, vol. 24, pp. 61-87.

DRONTSCHILOW, K.

1913. Metrische Studien an 93 Schädeln aus Kamerun. *Archiv für Anthropologie*, Bd. 12, pp. 161-183.

DUCKWORTH, W. L. H.

1900a. On a collection of crania with two skeletons of the Moriori, or aborigines of the Chatham Islands. *Journal of the Anthropological Institute*, new series, vol. 3, pp. 141-152.

1900b. A contribution to Eskimo craniology. *Journal of the Anthropological Institute*, new series, vol. 3, pp. 125-140.

1904a. Studies from the anthropological laboratory, the Anatomy School, Cambridge, England. Cambridge University Press.

1904b. Morphology and anthropology. Cambridge, England.

DUNN, L. C.

1928. An anthropometric study of Hawaiians of pure and mixed blood. *Papers, Peabody Museum of American Archaeology and Ethnology*, Harvard University, vol. 11, No. 3.

ELKIN, A. P.

1937. The nature of Australian languages. *Oceania*, vol. 8, pp. 127-169.

ENCYCLOPAEDIA BRITANNICA

1929. New Guinea. General account of the history, geography, and ethnology, 14th ed., vol. 16.

EPSTEIN, M., Editor

1941. *Statesman's Year Book*. London.

A compendium of geographical, social, and political information. Melanesian Islands, even the small ones, are described.

FALKENBURGER, F.

1938. Recherches anthropologiques sur la déformation artificielle du crâne. *Journal de la Société des Américanistes*, vol. 30, pp. 1-69.

FAWCETT, C. D., LEE, A., and others [PEARSON, K., Editor]

1902. A second study of the variation and correlation of the human skull with special reference to the Naqada crania. *Biometrika*, vol. 1, pp. 408-434.

FENNER, F. J.

1939. The Australian aboriginal skull. Its non-metrical morphological characters. *Transactions of the Royal Society of South Australia*, vol. 63, No. 2, pp. 249-306.

With important bibliography of modern writings on craniometry of Australian aborigines.

FERGUSON, J. A.

1941. *Bibliography of Australia*. Sidney and London, vol. 1, period 1784-1830. Other volumes to follow.

FIRTH, R.

1936. *We the Tikopia*. New York.

FISCHER, E.

1913. *Die Rehobother Bastards*. Jena.

FISHER, R. A.

1934. *Statistical methods for research workers*. Edinburgh.

1936. Coefficient of racial likeness and the future of craniometry. *Journal of the Royal Anthropological Institute*, vol. 66, pp. 57-63.

FLEURE, H. J., and DAVIES, E.

1936. Cephalic index and cranial morphology. *Memoirs and Proceedings of the Manchester Literary and Philosophical Society*, vol. 80, pp. 45-57.

FLOWER, W. H.

1880. On the cranial characters of the natives of the Fiji Islands. *Journal of the Anthropological Institute*, vol. 10, pp. 153-173.

1881. On a collection of monumental heads and artificially deformed crania from the island of Mallicollo (Malekula) in the New Hebrides. *Journal of the Anthropological Institute*, vol. 11, pp. 75-81. Illustration of deformation, p. 78.

The word "monumental" refers to heads that were temporarily buried, then treated with a composition.

1896. Note on a Moriori skull. *Journal of the Anthropological Institute*, vol. 26, pp. 295-296.

Refers to Moriori skulls described in Part 1 of the *Catalogue of the Royal College of Surgeons*, London, 1879.

FORNANDER, A.

1878. *The Polynesian race*. 3 vols. London.

FRANÇOIS, P. H.

1899. *Sur la déformation artificielle du crâne chez les Néo-Hébridais*. *Miscellanées biologiques, dédiées au Professor Alfred Giard*, Tome 7, pp. 230-249, Paris.

FRÉDÉRIC, J.

1905-6. Untersuchungen über die normale Obliteration der Schädelnähte. *Zeitschrift für Morphologie und Anthropologie*, vol. 9, pp. 373-455.

Large bibliography.

FRIDOLIN, J.

1904. *Tschuktschenschädel*. *Archiv für Anthropologie*, Bd. 28, Suppl., 17 pp.

FRIZZI, E.

1913. Osteometrischer Befund an Schädeln und Skeletteilen der sogenannten Telei in Süd-Bougainville. *Archiv für Anthropologie*, Bd. 12, pp. 241-272.

FÜRST, C. M., and HANSEN, FR. C. C.

1915. *Crania Gröenlandica*. Copenhagen.

A well-illustrated volume in English (pp. 1-234), with tables of measurements, plates, and a bibliography.

GIUFFRIDA-RUGGERI, V.

1905. Crani dell' Australia, della Nuova Caledonia e delle Isole Salomone. *Atti delle Società Romana di Antropologia*, vol. 12, pp. 4-6.

GLADWIN, T.

1941. The cranial index, a statistical study. *Human Biology*, vol. 13, pp. 88-102.

GOLDSTEIN, M. S.

1943. Demographic and bodily changes in descendants of Mexican immigrants. *Institute of Latin-American Studies, University of Texas*.

GRAF, L. A.

1931. *Ueber eine Schädelserie aus West-Neu-Guinea*. Zurich.

GRAY, H. (and collaborators)

1927. Auricular head height technique (five articles). *American Journal of Physical Anthropology*, vol. 11, pp. 301-351.

GRAY, J.

1901. Measurements of Papuan skulls. *Journal of the Anthropological Institute*, vol. 31, pp. 261-264.

GREGORY, W. K.

1922. *The origin and evolution of the human dentition*. Williams and Wilkins, Baltimore.

GRIMSHAW, B. E.

1907. *From Fiji to the cannibal islands*. London.

HADDON, A. C.

1915-16. Note antropologiche sui Papua occidentale della Nuova Guinea Inglese. *Rivista di Antropologia*, vol. 20, pp. 3-20.

HAMBLY, W. D.

1926. Origins of education among primitive people. *Vital statistics*, pp. 22-27. London.

1931. The preservation of local types of weapons and other objects in western Australia. *American Anthropologist*, vol. 33, pp. 1-15.

1936. Primitive hunters of Australia. *Field Museum of Natural History, Anthropology, Leaflet 32*.

1937. Source book for African anthropology. *Field Museum of Natural History, Anthropological Series*, vol. 26 (physical anthropology, pp. 161-220).

1938. Anthropometry of the Ovimbundu. *Field Museum of Natural History, Anthropological Series*, vol. 25, No. 2 (vital statistics, pp. 65-71).

1940. Craniometry of New Guinea. *Field Museum of Natural History, Anthropological Series*, vol. 25, No. 3.

HAMBRUCH, P.

1906. *Die Anthropologie von Kaniët*. *Mitteilungen aus dem Museum für Völkerkunde*, pp. 23-70.

HARRISON, T. H.

1936. Living with the people of Malekula. *Geographical Journal*, vol. 88, pp. 97-127.

HARROWER, G.

1926. A study of the Hokien and the Tamil skull. Transactions of the Royal Society of Edinburgh, vol. 54, pp. 573-599.

1928. A study of the crania of the Hylam Chinese. Biometrika, vol. 20B, pp. 245-278.

HASEBE, K.

1928. Die Westmikronesier. Arbeiten aus den Anatomische Institut des Kaiserliche-Japanischen Universität, Heft 13, Sendai.

HEINE-GELDERN, R.

1921. Gibt es eine austroasiatische Rasse? Archiv für Anthropologie, Bd. 18, pp. 79-99.

HELLMAN, M.

1928. Racial characters in human dentition. Proceedings of the American Philosophical Society, vol. 67, series 2, pp. 157-174.

HILTON-SIMPSON, M. W.

1921. Among the hill-folk of Algeria. London. Description of trephining, p. 186.

HOCART, A. M.

1919. Early Fijians. Journal of the Royal Anthropological Institute, vol. 49, pp. 42-51.

1929. Lau Islands, Fiji. Bernice P. Bishop Museum, Bulletin 62, Plate I.

HOGBIN, H. I.

1931. A note on Rennell Island. Oceania, vol. 2, pp. 174-178. For bibliography of Hogbin's works on Ontong Java see SHAPIRO, H. L. (1933).

HOOKE, BEATRICE G. E.

1926. A third study of the English skull with special reference to the Farringdon street crania. Biometrika, vol. 18, pp. 1-55.

HOOTON, E. A.

1930. The Indians of Pecos Pueblo; a study of their skeletal remains. New Haven.

1931. Up from the ape. New York.

HOWELLS, W. W.

1933. Anthropometry and blood types in Fiji and the Solomon Islands. American Museum of Natural History, Anthropological Papers, vol. 33, pt. 4, pp. 279-339.

1936. Some uses of the standard deviation in anthropometry. Human Biology, vol. 8, pp. 592-600.

1937a. Anthropometry of the natives of Arnhem Land and the Australian race problem. Papers, Peabody Museum of American Archaeology and Ethnology, Harvard University, vol. 16, No. 1.

1937b. The designation of the principal anthropometric landmarks on the head and skull. American Journal of Physical Anthropology, vol. 22, pp. 477-494.

1940. Physical determination of race. Contemporary Social Theory, pp. 264-278 [H. E. BARNES, Editor]. New York.

1941. The early Christian Irish; the skeletons at Gallen Priory. Proceedings of the Royal Irish Academy, vol. 46, section C, No. 3, pp. 103-119.

For standard deviations see pp. 142, 143.

HRDLICKA, A.

1903. Divisions of the parietal bone in man and other animals. Bulletin of the American Museum of Natural History, vol. 19, pp. 231-386.

1912. Artificial deformation of the human skull, with special reference to America. *Actas del Congreso Internacional de Americanistas*, Buenos Aires, vol. 17, pt. 1, pp. 147-149.
1920. *Anthropometry*. Philadelphia.
1924. Catalogue of human crania in the United States National Museum. *Proceedings of the United States National Museum*, vol. 63, pp. 1-51.
1925. Relation of the size of the head and skull to capacity in the two sexes. *American Journal of Physical Anthropology*, vol. 8, pp. 249-250 (explains ratio between cubic capacity and cranial module).
1927. Catalogue of crania of North American Indians. *Proceedings of the United States National Museum*, vol. 69, pp. 1-125.
1928. Catalogue of human crania in the United States National Museum collections. *Proceedings of the United States National Museum*, vol. 71, pp. 1-140.
1931. *Ibid.*, vol. 78, pp. 1-95.
1939. *Practical anthropometry*. Wistar Institute of Anatomy and Biology, Philadelphia.
1940. Lower jaw. *American Journal of Physical Anthropology*, vol. 27, pp. 281-308, 383-467.
1942. Crania of Siberia. *American Journal of Physical Anthropology*, vol. 29, pp. 435-472.
- HUMPHREYS, C. B.
1926. The southern New Hebrides, an ethnological record. Cambridge, England.
Measurements on the living, pp. 6-12, 125-127.
- ISSERLIS, L.
1914. Formulae for determination of the capacity of the Negro skull from external measurements. *Biometrika*, vol. 10, pp. 188-192.
- ITO, P. K.
1942. Comparative biometrical study of the physique of Japanese women born and reared under different environments. *Human Biology*, vol. 14, pp. 279-351.
- IVENS, W. G.
- 1933-35a. A grammar of the language of Florida, British Solomon Islands. *Bulletin of the School of Oriental Studies, London*, vol. 7, pp. 1073-1110.
- 1933-35b. A grammar of the language of Vaturanga, Guadalcanal, British Solomon Islands. *Bulletin of the School of Oriental Studies, London*, vol. 7, pp. 347-375.
- 1933-35c. A grammar of the language of Bugotu, Ysabel Island, Solomon Islands. *Bulletin of the School of Oriental Studies, London*, vol. 7, pp. 141-177.
- 1933-35d. A grammar of the language of Longgu, Guadalcanal, British Solomon Islands. *Bulletin of the School of Oriental Studies, London*, vol. 7, pp. 601-621.
- JENNESS, D.
1933. The problem of the Eskimo in "The American aborigines, their origin and antiquity." Toronto, pp. 373-396.
- JOLY, P. R.
1904. *Ethnographie des Nouvelles Hebrides*. *Bulletins et Mémoires de la Société d'Anthropologie de Paris*, vol. 5, sér. 5, pp. 356-369.

KATE, H. TEN

1916. Mélanges anthropologiques, Polynésiens. *L'Anthropologie*, vol. 27, pp. 393-406.

Measurements on living Tongans, p. 399.

KITSON, E.

1931. A study of the Negro skull with special reference to the crania from Kenya Colony. *Biometrika*, vol. 23, pp. 271-314.

KNOTT, V. B.

1941. Physical measurement of young children (3 to 6 years of age). *University of Iowa Studies in Child Welfare*, vol. 18, No. 3, serial No. 394.

KOGANEI, Y.

1894. Beiträge zur physischen Anthropologie der Aino. *Mitteilungen aus der Medicinischen Facultat der Kaiserlichen Universität, Tokio*, Bd. 2, pp. 1-403.

KRAUSE, R.

1881. Verzeichniss der Schädel und Skelete. Die Ethnographisch-Anthropologische Abtheilung des Museum Godeffroy, Hamburg, pp. 545-670.

New Hebrides, pp. 616-621.

KRIEGER, H. W.

1943. Island peoples of the western Pacific, Micronesia, and Melanesia. *Smithsonian Institution War Background Studies*, No. 16.

KROGMAN, W. M.

1927. Anthropological aspects of the human teeth and dentition. *Journal of Dental Research*, vol. 7, pp. 1-108.

1932. The morphological characters of the Australian skull. *Journal of Anatomy*, vol. 66, pp. 399-413.

1938. Cranial types from Alisar Hüyük. *Oriental Institute Publications*, Chicago, vol. 30, pp. 213-293.

1940. Racial types from Tepe Hissar, Iran. *Koninklijke Nederlandsche Akademie*. Amsterdam, pp. 1-83.

1941. A bibliography of human morphology (1914-1939). *University of Chicago Press*.

1943. What we do not know about race. *Scientific Monthly*, vol. 57, pp. 97-104.

KRZYWICKI, L.

1935. *Primitive society and its vital statistics*. London.

LAYARD, J. W.

1928. Degree-taking rites in South-West Bay, Malekula. *Journal of the Royal Anthropological Institute*, vol. 58, pp. 139-223.

1942. *The stone men of Malekula*. Toronto.

LEE, A.

1901. Reconstruction of the internal capacity of a skull from external measurements. *Philosophical Transactions of the Royal Society*, London, vol. 196A, pp. 225-264.

LEENHARDT, M.

1930. Notes d'ethnologie néo-calédonienne. *Travaux et Mémoires de l'Institut d'Ethnologie*, Paris, vol. 8, pp. 1-265.

Well illustrated.

1932. Documents néo-calédoniens. *Travaux et Mémoires de l'Institut d'Ethnologie*, Paris, vol. 9, pp. 1-514.

Linguistic studies.

1935. Vocabulaire et grammaire de la langue Houailou (New Caledonia).
Travaux et Mémoires de l'Institut d'Ethnologie, Paris, vol. 10, pp. 1-414.

LESTER, P.

1927. Contribution à l'anthropologie des Somalis. Bulletins et Mémoires de la Société d'Anthropologie de Paris, vol. 8, sér. 7, pp. 175-187.

1928. Etude anthropologique des populations de l'Ethiopie. L'Anthropologie, vol. 38, pp. 289-315.

LEWENZ, M. A., and PEARSON, K.

1904. On the measurement of internal capacity of cranial circumferences. Biometrika, vol. 3, pp. 366-392.

LEWIS, A. B.

1932. Ethnology of Melanesia. Field Museum of Natural History, Anthropology Guide, part 5.

LINTON, RALPH

1926. Ethnology of Melanesia and Polynesia. Field Museum of Natural History, Guide, pt. 6.

LUQUET, G. H.

1926. L'art néo-calédonien. Travaux et Mémoires de l'Institut d'Ethnologie, Paris, vol. 2, pp. 1-159.
Well illustrated.

LUSCHAN, F. VON

1907. Sammlung Baessler. Schädel von Polynesischen Inseln. Veröffentlichungen aus dem Königlichen Museum für Völkerkunde in Berlin, vol. 12.
Tables of measurements, pp. 212-241.

MACCURDY, G. G.

1914. Human skulls from Gazelle Peninsula, New Britain. The University Museum Anthropological Publications, University of Pennsylvania, vol. 6, No. 1, pp. 3-21.

MACDONELL, W. R.

1904. A study of the variation and correlation of the human skull with special reference to the English crania. Biometrika, vol. 3, pp. 191-244.

MACFADDEN, C. H.

1941. A selected bibliography of Pacific area maps. American Council, Institute of Pacific Relations, New York.

MANOUVRIER, L.

1884. Crânes trouvés à la Nouvelle-Calédonie. Bulletins de la Société d'Anthropologie de Paris, vol. 7, sér. 3, pp. 262-265.
Note on two skulls.

MANTEGAZZA, P.

1877. Studii antropologici ed etnografici sulla Nuova Guinea. Archivio per l'Antropologia e la Etnologia, vol. 7, pp. 137-172.

— and REGALIA, E.

1881. Nuovi studi craniologici sulla Nuova Guinea. Archivio per l'Antropologia e la Etnologia, vol. 11, pp. 149-185.

MARETT, J. R. DE LA H.

1935. Race, sex, and environment. London.

MARTIN, R.

1928. Lehrbuch der Anthropologie, 2nd ed., 3 vols. Jena.

MATTHEWS, W.

1898. Use of rubber bags in gauging cranial capacity. *American Anthropologist*, vol. 11, pp. 171-176.

MÉTRAUX, A.

1940. Ethnology of Easter Island. *Bulletin 160*, Bernice P. Bishop Museum, pp. 24-30. See SHAPIRO, H. L., for a report on the physical relationships of the Easter Islanders.

MEYER, A. B.

1877. Ueber 135 Papuaschädel von Neu-Guinea und der Insel Mysore. *Mitteilungen des Königlichen Zoologischen Museums zu Dresden*, Heft 2, pp. 61-100.

1886. Masse von Schädeln aus dem östlichen Teil des östindischen Archipels. *Zeitschrift für Ethnologie*, vol. 18, pp. 319-321.

MOLLISON, TH.

1908. Beitrag zur Kraniologie und Osteologie der Maori. *Zeitschrift für Morphologie und Anthropologie*, vol. 11, pp. 529-595.

MORANT, G. M.

1922. A first study of the Tibetan skull. *Biometrika*, vol. 14, pp. 227-246. Contour drawings.

1924. Nepalese Tibetan series. *Biometrika*, vol. 16, pp. 1-105.

1925. A study of Egyptian craniology from prehistoric to Roman times. *Biometrika*, vol. 17, pp. 1-52.

1927. A study of the Australian and Tasmanian skulls. *Biometrika*, vol. 19, pp. 417-440.

Cf. measurements with those given by HRDLICKA, A. (1928).

1928. A preliminary classification of European races based on cranial measurements. *Biometrika*, vol. 20B, pp. 300-365.

1931. A study of the recently excavated Spitalfields crania. *Biometrika*, vol. 23. Reduced coefficient of racial likeness, p. 214.

1935. An attempt to establish the relative variabilities of various populations. *Zeitschrift für Rassenkunde*, vol. 2, pp. 296-311.

1937. A contribution to Eskimo craniology based on previously published measurements. *Biometrika*, vol. 29, pp. 1-20.

1939a. The use of statistical methods in the investigation of problems of classification in anthropology. *Biometrika*, vol. 31, pp. 72-98.

1939b. Racial theories and international relations. *Journal of the Royal Anthropological Institute*, vol. 69, pp. 151-162.

—, TILDESLEY, M. L., and BUXTON, L. H. D.

1932. Standardization of the technique of physical anthropology. *Man*, No. 193.

MÜLLER, W.

1905. Beiträge zur Kraniologie der Neu-Britannier. 5 Beiheft, *Jahrbuch der Hamburger Wissenschaftlichen Anstalten*, vol. 23, pp. 71-187.

NEWTON, P.

1920. Negritos of the Philippines. *American Journal of Physical Anthropology*, vol. 3, pp. 5-24.

NIGG, C.

1930. A study of the blood-group distribution among Polynesians. *Journal of Immunology*, vol. 19, pp. 93-98.

OETTEKING, B.

1925. Skeletal remains from Santa Barbara, California. I. Craniology. Indian Notes and Monographs, No. 39. Museum of the American Indian, New York.

PARKINSON, R.

1907. Dreissig Jahre in der Südsee. Stuttgart.

PARSONS, F. G., and KEENE, L.

1919. Sexual differences in skulls. *Journal of Anatomy*, vol. 54, pp. 58-65.

PEARSON, K.

1920-21. Was the skull of the Moriori artificially deformed? *Biometrika*, vol. 13, pp. 338-346.

1926. On the coefficient of racial likeness. *Biometrika*, vol. 18, pp. 105-117.

1928. Note on standardization of method of using the coefficient of racial likeness. *Biometrika*, vol. 20B, pp. 376-382.

— and DAVIN, A. G.

1924. On the biometric constants of the human skull. *Biometrika*, vol. 16, pp. 328-363.

—, JACOB, S., and LEE, A.

1902-1903. Preliminary note on the inter-racial characters and their correlation in man. *Biometrika*, vol. 2, pp. 347-356.

— and TIPPETT, L. H. C.

1924. On stability of cephalic indices within the race. *Biometrika*, vol. 16, pp. 118-138.

PERMANENT COMMITTEE FOR GEOGRAPHICAL NAMES FOR BRITISH USE

1931, 1935. *Oceanic Names*. Published by the Royal Geographical Society, Kensington Gore, London, S.W. 7.

PHELPS, E. M.

1932. A critique of the principle of the horizontal plane of the skull. *American Journal of Physical Anthropology*, vol. 17, pp. 71-98.

PHILLIPS, G.

1931. The blood-groups of the Maori. *Human Biology*, vol. 3, pp. 282-288.

PITTARD, E.

1933. Les variations sexuelles de l'indice céphalique. *Revue Anthropologique*, vol. 43, pp. 69-80.

PITT-RIVERS, G. H. L. F.

1927. *The clash of culture and the contact of races*. London.

PÖCH, R.

1915. Studien an Eingeborenen von Neu-Südwaies und an australischen Schädeln. *Mitteilungen der Anthropologischen Gesellschaft in Wien*, vol. 45, pp. 12-96.

POLL, H.

1903. Ueber Schädel und Skelete der Bewohner der Chatham Inseln. *Zeitschrift für Morphologie und Anthropologie*, vol. 5, pp. 1-134.

PONIATOWSKI, S.

1911. Ueber den Wert der Indexklassifikationen. *Archiv für Anthropologie*, Bd. 10, pp. 52-54.

- POWELL, W.
1883. Wanderings in a wild country, or three years amongst the cannibals of New Britain. London.
- PYCRAFT, W. P.
1925. On the recognition of several species of post-Mousterian man; and the need for superseding the Frankfort base-line. *Man*, Nos. 105, 117.
- QUATREFAGES, A. DE, and HAMY, E. T.
1882. *Crania ethnica*. Paris.
Tasmanians, pp. 218-238; Papuans, pp. 238-296; Australians, pp. 297-326.
- RADCLIFFE-BROWN, A. R.
1927. The regulation of marriage in Ambrym. *Journal of the Royal Anthropological Institute*, vol. 57, pp. 343-348.
- RAY, S. H.
1893. The languages of the New Hebrides. *Journal and Proceedings of the Royal Society of New South Wales*, vol. 28, pp. 101-165.
1917. The people and language of Lifu, Loyalty Islands. *Journal of the Royal Anthropological Institute*, vol. 47, pp. 240-322.
- REDFIELD, R.
1943. What we do know about race. *Scientific Monthly*, vol. 57, pp. 193-201.
- REICHER, M.
1912. Untersuchungen über die Schädelform der alpenländischen und mongolischen Brachycephalen. *Zeitschrift für Morphologie und Anthropologie*, Bd. 15, pp. 422-562.
- RIED, H. A.
1915. Zur Anthropologie des abfluzlosen Rumpfschollenlandes im nordöstlichen Deutsch-Ostafrika. *Abhandlungen des Hamburgischen Kolonialinstituts*, vol. 31. See Series B, *Völkerkunde, Kulturgeschichte und Sprachen*, vol. 17, pp. 1-295.
- RISDON, D. L.
1939. A study of the crania and other human remains from Palestine (Lachish). *Biometrika*, vol. 31, pp. 99-166.
- RIVERS, W. H. R.
1914. *The history of Melanesian society*. Cambridge, England.
- ROBERTSON, A. W. D.
1910-11. Craniological observations on the lengths, breadths, and heights of a hundred aboriginal Australian crania. *Proceedings of the Royal Society of Edinburgh*, vol. 31, pp. 1-16.
- ROTH, H. L.
1899. *Aborigines of Tasmania*. Halifax, England.
- SARASIN, F.
1916-22. *Anthropologie der Neu-Caledonier and Loyalty-Insulaner*. Berlin.
- SARASIN, P., and SARASIN, F.
1892-93. *Ergebnisse naturwissenschaftlicher Forschungen auf Ceylon*. Wiesbaden, Bd. 3, pp. 198-307.
- SAUNDERS, C.
1922. *The population problem*. London.

SCHEBESTER, P., and LEHZELTER, V.

1933. Anthropology of the Central African pygmies in the Belgian Congo. Czech Academy of Sciences and Arts. Prague.
Anthropometry and type photographs.

SCHLAGINHAUFEN, O.

1907. Untersuchungen über den Sagittalumfang und seine Komponenten an 100 Schädeln aus Melanesien. Mitteilungen der Vereins für Erdkunde zu Dresden, Bd. 5, pp. 10-40.
- 1912-14. Anthropometrische Untersuchungen an Eingeborenen in Deutsch-Neuguinea. Abhandlungen und Berichte des Königlichen Zoologischen und Anthropologisch-Ethnographischen Museums zu Dresden, vol. 14, No. 5, pp. 5-82.
With a bibliography of 50 titles.
1929. Zur Anthropologie der mikronesischen Inselgruppe Kapingamarangi (Greenwich Islands). Archiv der Julius Klaus-Stiftung für Vererbungsforschung, Sozialanthropologie und Rassenhygiene. Bd. 4, Hefte 3-4, pp. 220-287.
1931. See GRAF, L. A. (1931) for Schlaginhaufen's data for New Ireland.
1939. Ein Melanesierschädel mit parietalia bipartita und anderen Nahtvariationen. From Kultur und Rasse, Festschrift zum 60. Geburtstag Otto Reches. Berlin.
1940. Die anthropologischen Materialien von Dr. Georg Höltker's Neuguinea Expedition. Bulletin der Schweizerischen Gesellschaft für Anthropologie und Ethnologie, vol. 16, pp. 13-15. Bern.

SCHMIDT, E.

1887. See KITSON, E. (1931), p. 289, for bibliographical details of Schmidt's researches on skulls of Negroes of Egypt, and Negroes of South Africa.
1888. Anthropologische Methoden. Leipzig.
An excellent textbook in its day, with a detailed section on craniometry. Apparatus is well illustrated. The descriptions are valuable for comparison with modern methods.

SCHMIDT, WILHELM

1899. Ueber das Verhältniss der melanischen Sprachen zu den polynesischen und untereinander. Vienna.
- 1912-14. Die Gliederung der australischen Sprachen. Anthropos, vol. 7, pp. 463-497; vol. 8, pp. 526-554; vol. 9, pp. 980-1017.

SCOTT, J. H.

1894. Contribution to the osteology of the aborigines of New Zealand and of the Chatham Islands. Transactions of the New Zealand Institute, vol. 26, pp. 1-64.

SELIGMAN, C. G.

1909. A classification of the natives of British New Guinea. Journal of the Royal Anthropological Institute, vol. 39, pp. 246-274.
With plates and description of living subjects.
1910. The Melanesians of British New Guinea. Cambridge, England.

SELTZER, C. C.

1937. A critique of the coefficient of racial likeness. American Journal of Physical Anthropology, vol. 23, pp. 101-109.

SERGI, G.

- 1892-93. Menschenvarietäten in Melanesien. Archiv für Anthropologie, Bd. 21, pp. 339-382.

SERGI, S.

1912. *Crania habessinica*. Rome. A volume containing 519 pp., devoted to craniometry of Hamitic and Semitic people of northeast Africa.
- 1915-16. L'indice cefalico in alcuni gruppi umani della costa settentrionale della Nuova Guinea. *Rivista di Antropologia*, vol. 20, pp. 3-12.
1926. Craniosteofo ro proiettometro mobile su triplice goniometro. *Rivista di Antropologia*, vol. 27, pp. 397-402.
1927. Pantogoniostato craniosteofo ro. *Rivista di Antropologia*, vol. 27, pp. 3-9.
Contains good photographs of the instrument, which is used in drawing skull contours.
1929. Assidiatetero. *Rivista di Antropologia*, vol. 28, pp. 3-4.
Further explanation of method of drawing contours.

SHAPIRO, H. L.

1930. The physical characters of the Society Islanders. *Memoirs, Bernice P. Bishop Museum*, vol. 11, pp. 275-283.
1931. The Alaskan Eskimo. A study of the relationship between the Eskimo and the Chipewyan Indians of central Canada. *American Museum of Natural History, Anthropological Papers*, vol. 31, pt. 6, pp. 347-385.
1933. The physical characteristics of the Ontong Javanese. A contribution to the study of the non-Melanesian elements in Melanesia. *American Museum of Natural History, Anthropological Papers*, vol. 33, pt. 3, pp. 231-278.
1939. *Migration and environment*. New York.
- 1940a. The distribution of blood groups in Polynesia. *American Journal of Physical Anthropology*, vol. 26, pp. 409-416.
- 1940b. The physical anthropology of the Maori-Moriori. *Journal of the Polynesian Society*, vol. 49, pp. 1-15.
- 1940c. The physical relationships of the Easter Islanders. A reprint from "Ethnology of Easter Island." See under METRAUX, A.
1942. The anthropology of Pukapuka. *American Museum of Natural History, Anthropological Papers*, vol. 38, pt. 3, 1942.

— and BUCK, P. H.

1936. The physical characters of the Cook Islanders. *Memoirs, Bernice P. Bishop Museum*, vol. 12.

SHARP, R. L.

1940. An Australian aboriginal population. *Human Biology*, vol. 12, pp. 481-507.

SHAW, J. C. M.

1931. The teeth, the bony palate and the mandible in Bantu races of South Africa. London.

SHRUBSALL, F.

- For a bibliography of the research of Shrubsall on skulls of African Negroes, Bushmen, and Hottentots, see KITSON, E. (1931, pp. 286, 288, 289).

SIMMONS, K.

1942. Cranial capacities by both plastic and water techniques with cranial linear measurements of the reserve collection, White and Negro. *Human Biology*, vol. 14, pp. 473-498.

SIMPSON, G. G., and ROE, A.

1939. *Quantitative zoology*. Numerical concepts and methods in the study of recent and fossil animals. New York and London.

SLATER, H.

1901. Maori craniometry. *Journal of the Royal Anthropological Society of South Australasia*. New series, vol. 3, No. 12, pp. 211-212.

SMITH, P. S.

1904. *Hawaiki, the original home of the Maori*. London, 1904.

SNYDER, L. H.

1926. Human blood groups, their inheritance and racial significance. *American Journal of Physical Anthropology*, vol. 9, pp. 233-263.

SPEISER, F.

1912. Reisebericht über Tanna, Neue Hebriden. *Zeitschrift für Ethnologie*, vol. 44, pp. 297-298.

1913. Two years with the natives in the western Pacific. London.

1923a. Anthropologische Messungen aus den Santa Cruz Inseln. *Archiv für Anthropologie*, Bd. 19, pp. 89-146.

1923b. Ethnographische Materialien aus den Neuen Hebriden, und den Ban Inseln. Berlin.

1929. Anthropologische Messungen aus Espiritu Santo (Neue Hebriden). *Verhandlungen der Naturforschenden Gesellschaft in Basel*, Bd. 39.

SPENCER, B., and GILLEN, F. J.

1912. *Across Australia*. 2 vols. London.

STATESMAN'S YEAR BOOK. See EPSTEIN, M.

STEFFAN, P.

1929. Die Beziehungen zwischen Blutgruppe, Pigment und Kopfform. *Zeitschrift für Rassenphysiologie*, vol. 1, pp. 121-142.

STEIN, R., and EPSTEIN, J. L.

1934. The molar teeth of New Britain Melanesians. *Journal of the American Dental Association*, vol. 21, pp. 1409-1413.

STEWART, T. D.

1936. Anthropometric nomenclature. 1. The cephalic (length-breadth) index. *American Journal of Physical Anthropology*, vol. 22, No. 1, pp. 97-140.

1937. An examination of the Breiteringer method of cranial capacity determination. *American Journal of Physical Anthropology*, vol. 23, pp. 111-121.

1939. Anthropometric observations on the Eskimos and Indians of Labrador. *Field Museum of Natural History, Anthropological Series*, vol. 31, No. 1.

1942. Anthropometric nomenclature. The indices of head height. *American Journal of Physical Anthropology*, vol. 29, pp. 23-39.

STIRLING, E. C.

1896. Report on the work of the Horn Scientific Expedition to central Australia. Part IV: Anthropology. Melbourne.

STIRLING, M. W.

1943. The native peoples of New Guinea. *Smithsonian Institution War Background Studies*, No. 9.

STOESSIGER, B. N., and MORANT, G. M.

1927. A study of the Badarian crania recently excavated by the British School of Archaeology in Egypt. *Biometrika*, vol. 19, pp. 110-150.

1932. A study of the crania in the vaulted ambulatory of Saint Leonard's church, Hythe. *Biometrika*, vol. 24, pp. 135-202.

STRANDSKOV, H. H.

1942. Variance of human live birth sex ratios. *Human Biology*, vol. 14, pp. 85-94.

SULLIVAN, L. R.

1918. Racial types in the Philippine Islands. *American Museum of Natural History, Anthropological Papers*, vol. 23, pp. 1-61.
1921. A contribution to Samoan somatology. *Memoirs, Bernice P. Bishop Museum*, vol. 8, pp. 81-98.
1922. Tongan somatology, *Memoirs, Bernice P. Bishop Museum*, vol. 8, pp. 233-260.
- 1923a. Marquesan somatology. *Memoirs, Bernice P. Bishop Museum*, vol. 9, pp. 142-249.
- 1923b. The racial diversity of the Polynesian people. *Journal of the Polynesian Society*, vol. 32, pp. 79-84.
1924. Race types in Polynesia. *American Anthropologist*, vol. 26, pp. 22-26.
1927. Hawaiian somatology. *Memoirs, Bernice P. Bishop Museum*, vol. 9, pp. 269-342.

THILENIUS, G.

- 1905-06. Die Bedeutung der Meeresströmungen für die Besiedelung Melanesiens. *Mitteilungen aus dem Museum für Völkerkunde in Hamburg*, pp. 1-21.
- With maps showing ocean currents and probable migrations of Melanesians.

THOMAS, O.

1884. Account of a collection of human skulls from Torres Straits. *Journal of the Anthropological Institute*, vol. 14, pp. 328-343.

THOMPSON, L.

1938. The culture history of the Lau Islands, Fiji. *American Anthropologist*, vol. 40, pp. 181-197.
- 1940a. Southern Lau, Fiji, an ethnography. *Bulletin 162, Bernice P. Bishop Museum*.
- 1940b. Fijian frontier. San Francisco. *American Council, Institute of Pacific Relations, Studies of the Pacific*, No. 4.

THOMSON, A., and BUXTON, L. H. D.

1923. Man's nasal index in relation to certain climatic conditions. *Journal of the Royal Anthropological Institute*, vol. 53, pp. 92-122.

THOMSON, E. Y.

- 1915-17. A study of the crania of the Moriori, or aborigines of the Chatham Islands, now in the Museum of the Royal College of Surgeons, London. *Biometrika*, vol. 11, pp. 82-135.

TILDESLEY, M. L.

- 1921a. Table for calculating occipital index. *Biometrika*, vol. 13, pp. 261-262.
- 1921b. A first study of the Burmese skull. *Biometrika*, vol. 13, pp. 185-229 (contours).
1927. Determination of the cranial capacity of the Negro from measurements of the skull or the living head. *Biometrika*, vol. 19, pp. 204-206.
1938. Measurements of head length and breadth. The systems of Broca, Topinard, Monaco agreement, British Association, Martin, compared. *Man*, Nos. 103, 144.
1939. Congrès International des Sciences Anthropologiques et Ethnologiques: Comité de Standardisation de la Technique Anthropologique. *Man*, No. 68.
- 1940a. Extent to which the grouping of the data affects the accuracy of mean values. *Man*, No. 156.
- 1940b. Sources and extent of errors in estimating standard deviations of normally distributed populations. *Man*, No. 180.

TODD, T. W.

1923. Cranial capacity and linear dimensions in White and Negro. *American Journal of Physical Anthropology*, vol. 6, No. 2, pp. 98-194.

— and LYON, D. W., JR.

1924. Endocranial suture closure: Its progress and age relationship. *American Journal of Physical Anthropology*, vol. 7, pp. 325-383.

1927. Skeletal records of mortality. *Scientific Monthly*, vol. 24, pp. 481-496.

TREVOR, J. C.

1938. Some anthropological characters of hybrid populations. *Eugenics Review*, vol. 30, pp. 21-31.

TURNER, W.

1884. Report on the scientific results of the voyage of H.M.S. Challenger, 1873-76. Report on the human crania and other bones of the skeleton. *Zoology*, vol. 10, No. 4, pt. 1, p. 9; vol. 16, No. 4, pt. 2, pp. 4-128.

1899. Contributions to the craniology of the people of the Empire of India. Part I: The hill tribes of the north-east frontier and the people of Burma. *Proceedings of the Royal Society of Edinburgh*, vol. 22, pp. 550-552.

1900. Contributions to the craniology of the people of India. Part II: The aborigines of Chota Nâgpûr, of the central provinces and the people of Orissa. *Proceedings of the Royal Society of Edinburgh*, vol. 23, pp. 161-162.

1906. Contributions to the craniology of the people of the Empire of India. Part III: Natives of the Madras Presidency, Thugs, Veddahs, Tibetans, and Seistanis. *Transactions of the Royal Society of Edinburgh*, vol. 45, pp. 261-310.

1907. A contribution to the craniology of the natives of Borneo, the Malays, native Formosans, and Tibetans. *Transactions of the Royal Society of Edinburgh*, vol. 45, pp. 781-818.

1909. The craniology, racial affinities, and descent of the aborigines of Tasmania. *Transactions of the Royal Society of Edinburgh*, vol. 46, pp. 365-404.

1910. The aborigines of Tasmania. *Transactions of the Royal Society of Edinburgh*, vol. 47, pp. 411-454.

1913. Contributions to the craniology of the people of the Empire of India. Part IV: Bhils, frontier tribes of Burma, Pakôkku tribes, South Shan tribes, Tibetans. *Transactions of the Royal Society of Edinburgh*, vol. 49, pp. 705-734.

VOLZ, W.

1895. Beiträge zur Anthropologie der Südsee. *Archiv für Anthropologie*, Bd. 23, pp. 97-169.

Skulls from Easter Island. Large bibliography, geographically arranged.

WAGNER, K. A.

1937. The craniology of the Oceanic races. *Skrifter Utgitt av Det Norske Videnskaps Akademi i Oslo. I. Matematisk-Naturvidens-kapelig Klasse. No. 2*, pp. 7-193.

With bibliography of about 150 titles.

WECKLER, J. E., JR.

1943. Polynesians—explorers of the Pacific. *Smithsonian Institution War Background Studies*, No. 6.

WEISBACH, M.

1890. Der Maorischädel. *Mitteilungen der anthropologischen Gesellschaft, Vienna*, vol. 20, pp. 32-37.

WENINGER, J.

1927. Eine morphologisch-anthropologische Studie. Durchgeführt an 100 westafrikanischen Negern. Vienna.

WIDENMANN, DR.

1898. Untersuchung von 30 Dschaggaschädeln. Archiv für Anthropologie, Bd. 25, pp. 362-396.

WILDER, H. H.

1920. A laboratory manual of anthropometry. Philadelphia.

WILLIAMSON, R. W.

1924. The social and political systems of central Polynesia. 3 vols., Cambridge, England.

1933. Religious and cosmic beliefs of central Polynesia. 2 vols., Cambridge, England.

WIRZ, P.

1926. Untersuchungen an Schädeln und Skeletteilen aus dem Gebiet der Humboldt-Bai und dem südlichen Küstengebiet von Holländisch Neu-Guinea. Nova Guinea, vol. 16, pp. 149-250.

WISSLER, C.

1927a. Observations on Hawaiian somatology. Memoirs, Bernice P. Bishop Museum, vol. 9, pp. 1-343.

1927b. Race and sex differences in growth of head form. Eugenical News, vol. 12, pp. 81-84.

WOLLASTON, A. F. R.

1912. Pygmies and Papuans. Measurements of Tapiro Pygmies, Appendix B, p. 321. New York.

WOO, T. L., and MORANT, G. M.

1931. On the asymmetry of the human skull. Biometrika, vol. 22, pp. 324-352.

1932. A preliminary classification of Asiatic races based on cranial measurements. Biometrika, vol. 24, pp. 108-134.

WOOD-JONES, F.

1929. The Australian skull. Journal of Anatomy, vol. 63, pp. 352-354.

1930. The Polynesian race: A question of anthropometric method. Man, vol. 30, pp. 60-64.

1931a. Non-metrical morphological characters of the Hawaiian skull. Journal of Anatomy, vol. 65, pp. 368-378.

1931b. The non-metrical morphological characters of the skull as criteria for racial diagnosis. Journal of Anatomy, vol. 65, pp. 179-195.

1933. The non-metrical morphological characters of the Tasmanian skull. Journal of Anatomy, vol. 67, pp. 583-590.

1936. Skulls from the Purari Plateau, New Guinea. Journal of Anatomy, vol. 70, pt. 2, pp. 405-409.

— and CAMPBELL, T. D.

1924. Anthropological and descriptive observations on some South Australian aborigines, with a summary of some previously recorded anthropometric data. Transactions of the Royal Society of South Australia, vol. 48, pp. 303-312.

WUNDERLY, J.

1938. The origin of the Tasmanian race. Man, No. 217.

With bibliography.

1939. The cranial and other skeletal remains of Tasmanians in collections in the Commonwealth of Australia. Biometrika, vol. 30, pp. 305-340.

— and WOOD-JONES, F.

1933. The non-metrical morphological characters of the Tasmanian skull. *Journal of Anatomy*, vol. 67, pp. 583-595.

YOUNG, M.

1916. A contribution to the study of the Scottish skull. *Transactions of the Royal Society of Edinburgh*, vol. 51, pt. 2, No. 9, pp. 347-454.

1931. The west Scottish skull and its affinities. *Biometrika*, vol. 23, pp. 10-22.

YULE, G. UDNY

1937. *An introduction to the theory of statistics*. London.

INDEX

- Africa, see Angola, Bushmen, Cameroons, Congo, Egyptian, Galla, Negro, Somali, WaTeita
- Age, grouping of skulls by, 11, 9-15
- Alveolar prognathism, a sex determinant, 28; see Angles, and P angle
- Ambrym skulls, average measurements of, tabulated, 44; contour drawings of, 42; individual measurements of and their averages, 71-78; likeness of, to Australian, African Negro, and Polynesian, 58; sex ratios of measurements of, 30; traits of, compared with those of Australian, Negro, New Britain, and Polynesian, 43, 50, 56, 57, 66, 67; standard deviations for measurements of, females, 119-120, males, 107-110; teeth of, described, 83, measurements of, tabulated, 84
- Anatomical methods favored by some anthropologists, 9
- Ancestral skulls, 27
- Angles of the face, 18, 32; see Averages of skull measurements
- Angola, longevity of Negroes in, 13
- Ansteckgoniometer, use of, 20
- Australian aborigines, longevity of, 13
- Australian skulls, jaws of, 82; likeness of, to those of Ambrym, Negro, New Britain, New Guinea, 7, 25, 44, 48, 50; literature describing, 48; morphology of, 51-54; standard deviations for measurements of, 99-102, 107-110, 119, 120; teeth of, measurements of, tabulated, 85
- Averages of skull measurements, tabulated, for Ambrym, New Guinea, New Britain, 44, 45; for Ambrym, Australia, East Africa, Polynesia, 54, 55
- Birth, sex ratios at, 14
- Bizygomatic width, a sex determinant 28
- Blood grouping of Australian tribes, 52, 53
- Brachycephaly, limits of, 29
- Breadth-length index, changes of, with age, 28; see Averages of skull measurements, Cranial index
- Burmese skulls, measurements of, by Tildesley, 42
- Bushmen, of South Africa, 7; standard deviations of skull measurements of, 103-106; teeth of, measurements of, tabulated, 85
- Cameroons, West Africa, standard deviations of skull measurements from, 103-106
- Childbirth, mortality of women related to, 14
- Chinese skulls, standard deviations of measurements of, 107-110
- Congo, Africa, standard deviations of skull measurements from, 103-106
- Contour drawings, comparison of skulls from various regions by, 42, 50; technique of making, 19
- Cranial capacity, formula to estimate, 24; likeness of, in skulls of Ambrym, Australia, Negroes of East Africa, 53; technique for measuring, 21; see Averages of skull measurements
- Cranial index, age in relation to, 29; classification of, by magnitude, 29; sex in relation to, 35; variability of, for different races, 40; see Averages of skull measurements
- Cranial module, 16
- Culture contacts and longevity, 15
- Czechoslovakian skulls, sex differences of, 27
- Definitions of points of measurement on skulls, 17

- Deformed skulls of Malekula, standard deviations of measurements of, 99-102
- Differences in average skull measurements, for Ambrym, New Britain, New Guinea, classified and tabulated, 46
- Dolichocephaly, limits of, 29
- Egyptian skulls, standard deviations of measurements of, 99-102, 103-106, 119-120; variability of traits of, 38
- England, mediaeval, longevity in, 15
- Environment and change of head form, 28
- Ethnological customs, possible effect of, on skull samples, 27
- Facial angles, close resemblance of, for skulls of Ambrym, New Britain, New Guinea, 47; as criteria of race, 67; physiognomy determined by, 18
- Fiji, Polynesian influences upon, 60
- Foramen magnum, measurements of, of dubious value, 18
- Formula, cranial capacity estimated by, 24; significance of differences in averages found by, 24; see Standard deviations
- Frankfort plane, validity of, 19, 20
- Gaboon, West Africa, standard deviations of skull measurements from, 103-106
- Galla, tribe of northeast Africa, standard deviations of skull measurements from, 103-106
- Glabella, determinant of sex, 27; prominent in Australian skulls, 50
- Gonial angle as criterion of race, 81
- Hawaii, standard deviations of skulls from, 99-102
- Headhunters, longevity of, 14; skull trophies of, 27
- Hythe, England, standard deviations of skull traits from, females, 119, 120, males, 99-102; variability of skull traits, 38, 39
- Indians of North America, standard deviations of skull measurements of, 111-118
- Indices of cranial measurements, similarity of, for both sexes, 32; see Averages of skull measurements
- Individual skull measurements for Ambrym, 71-78
- Instruments, cranial measurements by, 19-21; palatal depth measured by, 44
- Inter-racial standard deviations for skull measurements, 115-118
- Iran, longevity at Tepe Hissar, 15; standard deviations of skull measurements from, females, 121-124, males, 103-110
- Jaws, measurements of, 81
- Kaffirs, South Africa, standard deviations of skull measurements of, 103-106
- Kanet Island, near New Guinea, standard deviations of skull measurements from, 99-102
- Lachish, Palestine, standard deviations of skull measurements from, females, 121-124, males, 103-106
- Language, Polynesian influences on Melanesian, 3, 60
- London School of Oriental Studies, Melanesian languages investigated by, 3, 60
- Longevity, a modern achievement, 15; see Mortality, Age
- Loyalty Islands touched by Polynesian influence, 60
- Magic, disease and longevity related to, 14
- Malekula, New Hebrides Islands, standard deviations of measurements of deformed skulls from, females, 121-124, males, 99-102
- Maori skulls, contour drawings of, 50; literature relating to, 51; standard deviations of skull measurements of, females, 121-124, males, 99-102
- Mastoids, sex determination by, 27

- Melanesian skulls, average measurements tabulated, 44-47; Old English skulls compared with, 49; see Ambrym, New Britain, New Guinea
- Mesocephaly, limits of, defined, 29
- Mortality of various peoples, judged by skull populations, 9-15
- Negro (African) skulls, average measurements of, tabulated, 25, 54, 55; contour drawings of, 50; jaw measurements of, 82; longevity as judged by, 13; standard deviations for measurements of, females, 121-124, males, 103-106; teeth of, 82, 85
- New Britain skulls, average measurements of, 44; compared with those of Australia, 25, Old London, 49, Ambrym, 43; contour drawings of, 42; longevity as judged by, 13; sex ratios of, 30; standard deviations of measurements of, 99-102; teeth of, measured, 84
- New Caledonia, Polynesian influence in, 60; standard deviations of skull measurements from, 107-110
- New Guinea skulls, average measurements of, 44; contour drawings of, 23, 42; P angle and prosthion P angle of, 18; proportion of sexes in, 26; sex ratios of measurements of, 30; compared with those from Africa, 25, Australia 48, New Britain, 45, 46, Old London, 49; standard deviations of measurements of, 99-102, 119-120, 121-124; variability in measurements for the sexes, 37
- New Ireland, standard deviations of skull measurements from, 107-110
- North American Indians, standard deviations of skull measurements of, 111-118
- Nose, different points of measurement on, 16; width of, compared for skulls of Ambrym, Australia, Polynesia, 54, 55; see Averages of skull measurements
- Occipital index, significance of, 18; variability of, in different races, 39
- Occipital torus, as a determinant of sex, 27
- Orbital index, as a determinant of sex, 35
- Ovimbundu, a Negro tribe of Angola, longevity among, 13
- Palate, length of, two ways of measuring, 18; measurements of, in relation to teeth, 83; variability of measurements on, 38, 44
- Palatometer, for measuring palatal depth, 20
- Palestine, standard deviations of skull measurements from, females, 121-124, males, 103-106
- P angle, measurements of, compared with those of the prosthion P angle, 20; variability of, in relation to race, 40
- Pecos, New Mexico, longevity, as judged by skull population from, 15; sex incidence in skull population from, 26; standard deviations of skull measurements from, females, 121-124, males, 107-110
- Percentage, probable error of, formula for calculating, 12
- Physical attributes of Ambrym people, 3, 4; see Ambrym
- Physiognomy, determination of, by facial angles, 18; type of, preserved in both sexes, 32
- Polynesians, average skull measurements of, 51, 54, 55; comparison of skulls with those of Australia, African Negroes, Melanesians, 57, 58; voyages of, and their influence in Melanesia, 60
- Prognathism, 28; see Angles, Facial angles, P angle
- Samoa, a point of Polynesian migrations, 160
- Sand for measuring cranial capacities, 22, 23
- Scottish skulls, standard deviations for measurements of, females, 121-124, males, 115-118
- Seed for measuring cranial capacities, 21-23

- Sex, contour drawings of skulls showing differences of, 4, 29; differences of, in skulls from Ambrym, 34; literature relating to differences of, 27, 28; proportion of males to females in skull population, 26, 27; ratios of skull measurements for, 30; statistical comparison of differences for, 33, 34; traits of, in relation to race, 28; traits for distinguishing, 34; variability of skull measurements according to, 36
- Shot for measuring cranial capacities, 21, 23
- Solomon Islands, standard deviations of skull measurements from, 107-110
- Somali, northeast Africa, standard deviations of skull measurements from, 103-106
- Standard deviations, of skull measurements, classified and tabulated, 99-124; discussion of, 89-97; inter-racial values, by taking weighted averages for many different populations, 115-118; key to the identity of, tabulated, 97, 98
- Stativgoniometer, use of, 20
- Summary, of chapters, 62-67; of skull traits for Ambrym, Australia, Negroes, Polynesians, 59
- Supraorbital ridges, a sex determinant, 27
- Tanganyika Territory, east Africa, standard deviations of skull measurements of the WaTeita tribe of, 103-106
- Tasmanians, facial expression and upper facial height measurement of, 7; standard deviations of skull measurements of, 62
- Teeth, of Melanesians, Negroes, Australians, measurements of, tabulated and discussed, 81-84
- Uraniscometer, for measuring palatal depth, 20
- Variability of skull traits in relation to sex and race, 36-39
- WaTeita, Negro tribe of east Africa, average cranial measurements of, tabulated, 54, 55; standard deviations of skull measurements of, females, 121-124, males, 103-106
- Weight of skull, seldom recorded, 19; value as a sex determinant of, 28; see Averages of skull measurements

PLATES

SKULLS OF AMBRYM ISLAND

See Tables (pp. 71-78) for Measurements

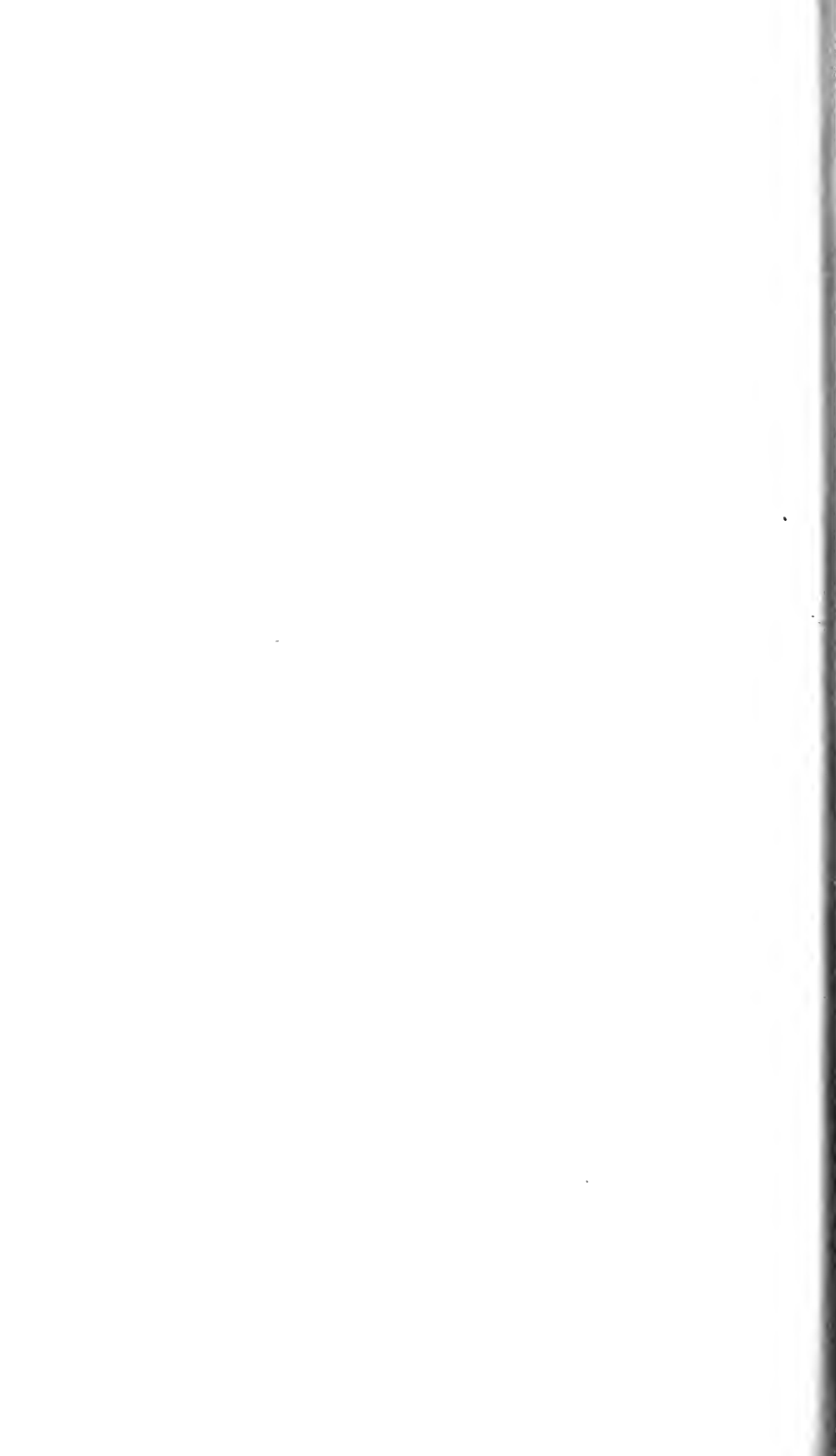



SKULL No. 43067



SKULL No. 43067



SKULL No. 43067



SKULL No. 43067



SKULL No. 43067



SKULL No. 43076



SKULL No. 43076



BRIDGE AND TOWN



SKULL No. 43076



SKULL No. 43076



SKULL No. 43072



SKULL No. 43072



SKULL No. 43072



SKULL No. 43072

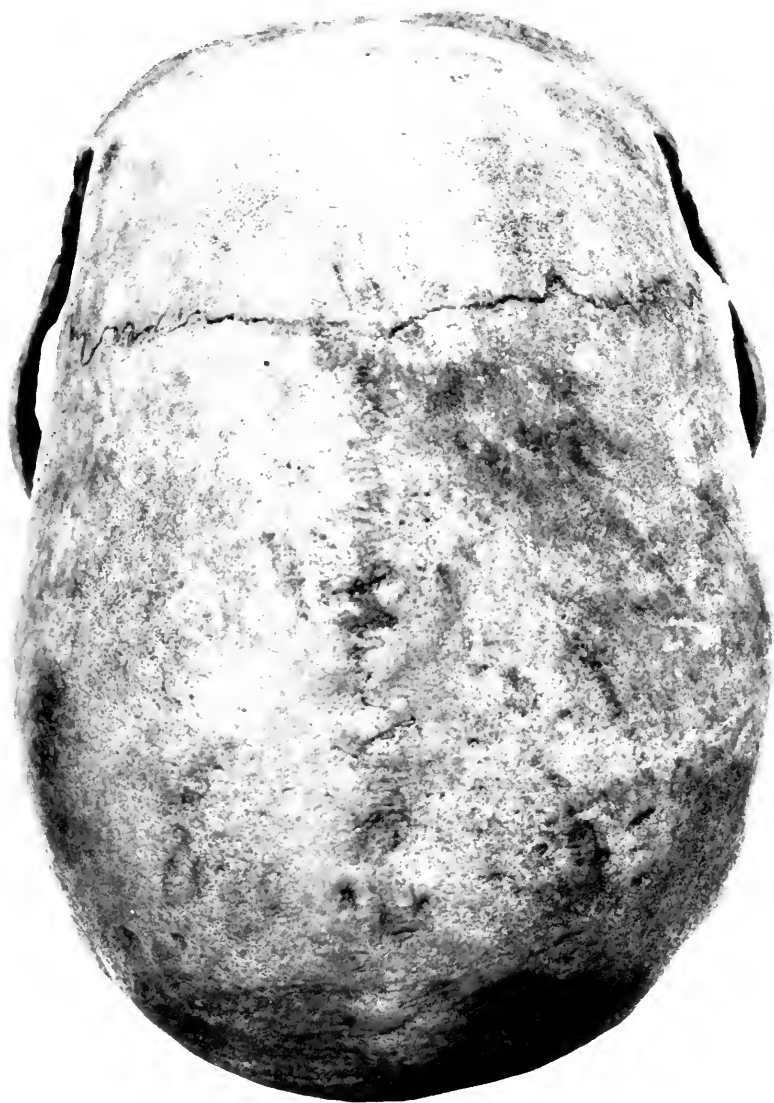

SKULL No. 43072



SKULL No. 43060



SKULL No. 43060





SKULL No. 43060



SKULL No. 43060



SKULL No. 43069



SKULL No. 43069

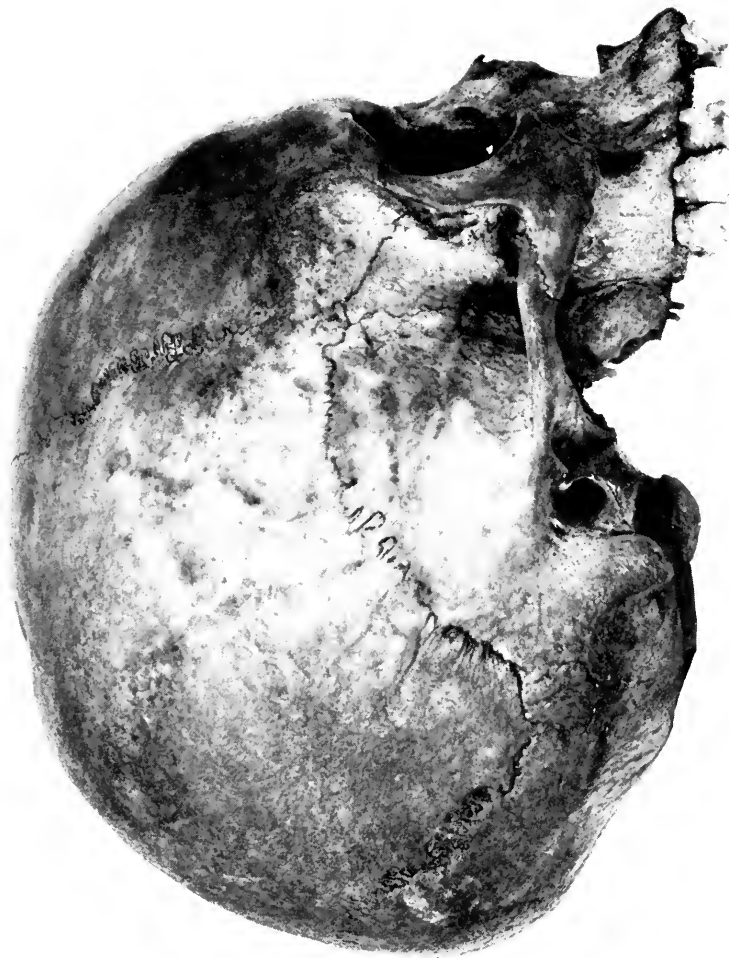



SKULL No. 43069



SKULL No. 43069



SKULL No. 43078



SKULL No. 43078





SKULL No. 43078

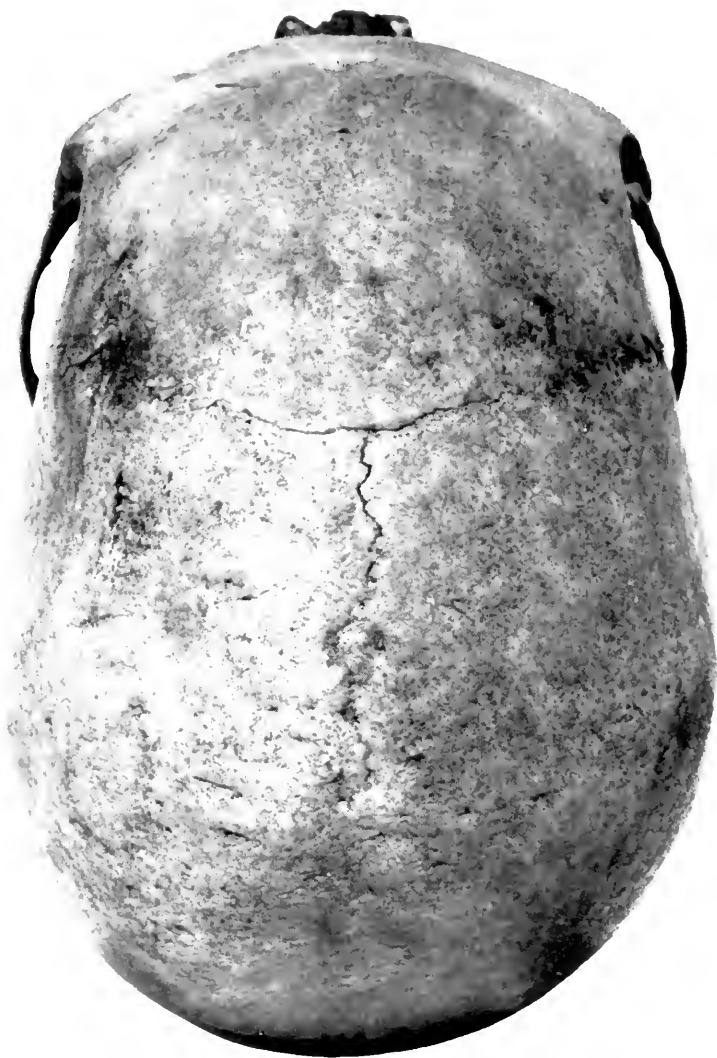

SKULL No. 43078



UNIVERSITY OF ILLINOIS-URBANA



3 0112 004043805